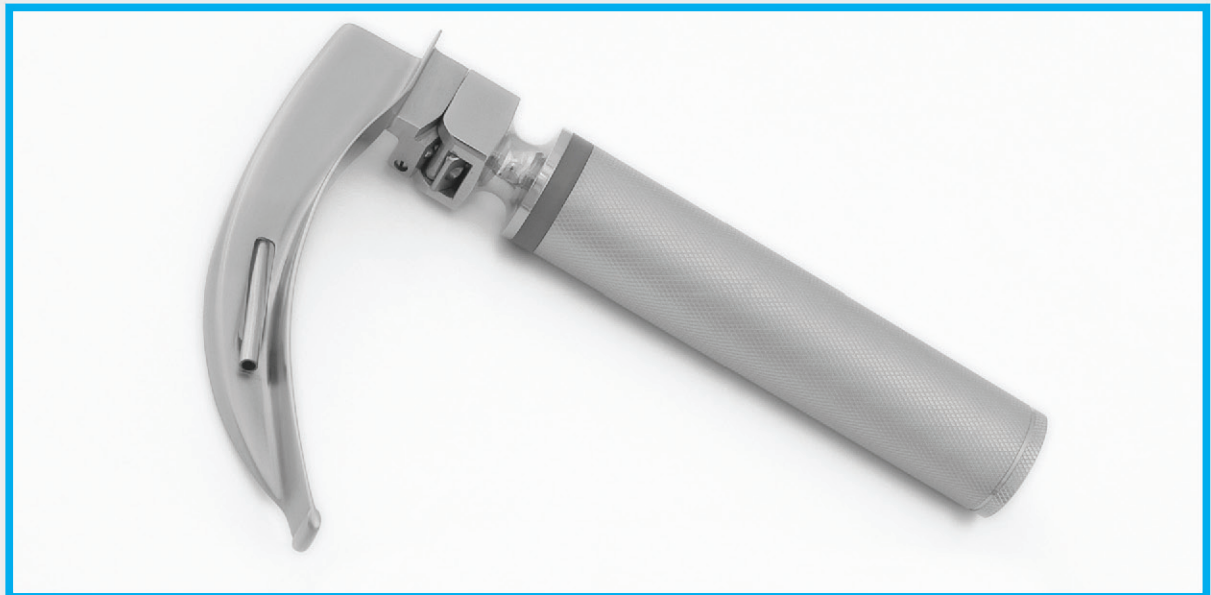


**EN** Anaesthesia

**DE** Narkose

**ES** Anestesia

Page 22 to 37

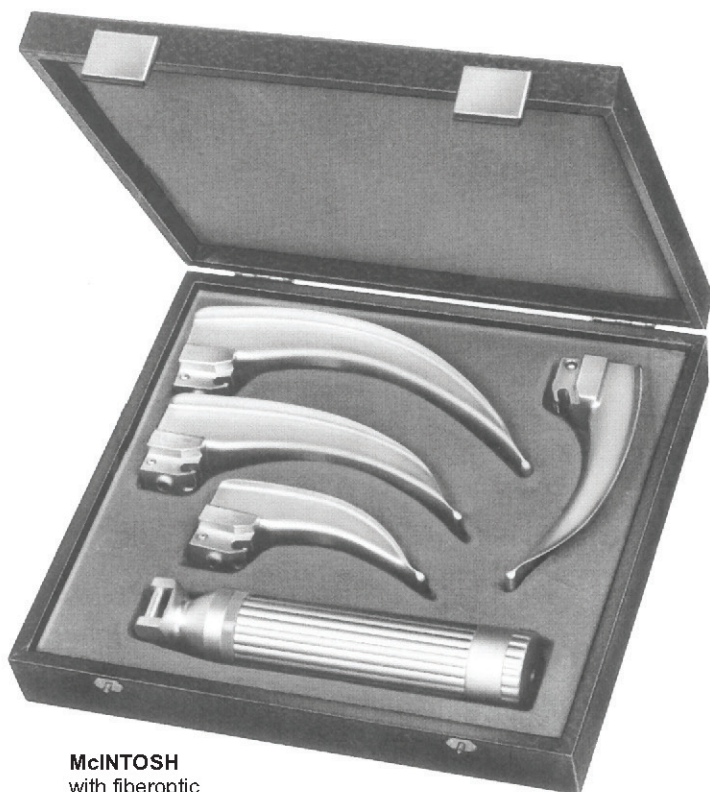




OI 03-1204-00  
Battery handle



fiber optic



**McINTOSH**  
with fiberoptic

OI 03-1201-00  
set with 4 blades, battery handle  
(without batteries)  
Fig. 1 to 4, in case

OI 03-1202-00  
set with 3 blades, battery handle  
(without batteries)  
Fig. 1 to 3, in case



OI 03-1203-00  
Fig. 0  
for babies  
55 mm



OI 03-1203-01  
Fig. 1  
for children  
70 mm



OI 03-1203-02  
Fig. 2  
for adolescents  
80 mm



OI 03-1203-03  
Fig. 3  
for women  
105 mm



OI 03-1203-04  
Fig. 4  
for men  
130 mm





**FOREGGER**  
 with fiberoptic

OI 03-1205-00  
 set with 4 blades, battery handle  
 (without batteries)  
 Fig. 1 to 4, in case

OI 03-1205-01  
 set with 3 blades, battery handle  
 (without batteries)  
 Fig. 2 to 4, in case



OI 03-1204-00  
 Battery handle



Laryngoscope Sets  
 fiber optic



OI 03-1206-00  
 Fig. 0  
 for babies  
 55 mm



OI 03-1206-01  
 Fig. 1  
 for children  
 70 mm



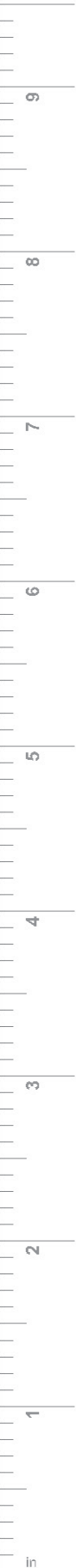
OI 03-1206-02  
 Fig. 2  
 for adolescents  
 90 mm



OI 03-1206-03  
 Fig. 3  
 for women  
 110 mm



OI 03-1206-04  
 Fig. 4  
 for men  
 135 mm





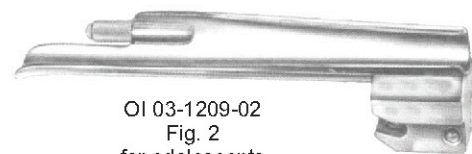
**FOREGGER**  
 OI 03-1207-00  
 set with 3 blades  
 Fig. 2 to 4, in case



**FOREGGER**  
 OI 03-1208-00  
 set with 4 blades  
 in case  
 Fig. 1 to 4, in case



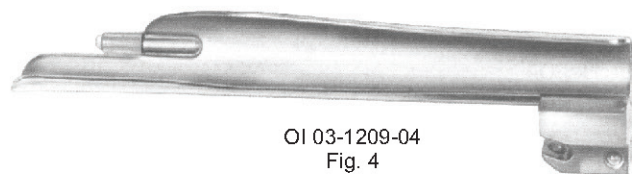
OI 03-1209-01  
 Fig. 1  
 for children  
 70 mm



OI 03-1209-02  
 Fig. 2  
 for adolescents  
 90 mm



OI 03-1209-03  
 Fig. 3  
 for women  
 110 mm



OI 03-1209-04  
 Fig. 4  
 for men  
 135 mm





OI 03-1210-00  
Battery handle



OI 03-1211-00  
Battery handle



OI 03-1212-00  
Battery handle



OI 03-1213-00  
spare bulb small  
for blades fig. 0 to 1



OI 03-1214-00  
spare bulb large  
for blades fig. 2 to 4



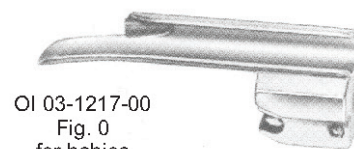


**MILLER**  
OI 03-1215-00  
with battery handle (without batteries)  
and three laryngoscope blades  
fig. 1 to 3, complete, in case

**MILLER**  
OI 03-1216-00  
with battery handle (without batteries)  
and four laryngoscope blades  
fig. 1 to 4, complete, in case



Laryngoscope Sets  
fiber optic



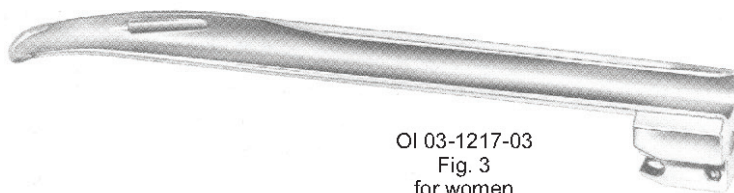
OI 03-1217-00  
Fig. 0  
for babies  
55 mm



OI 03-1217-01  
Fig. 1  
for children  
80 mm



OI 03-1217-02  
Fig. 2  
for adolescents  
130 mm

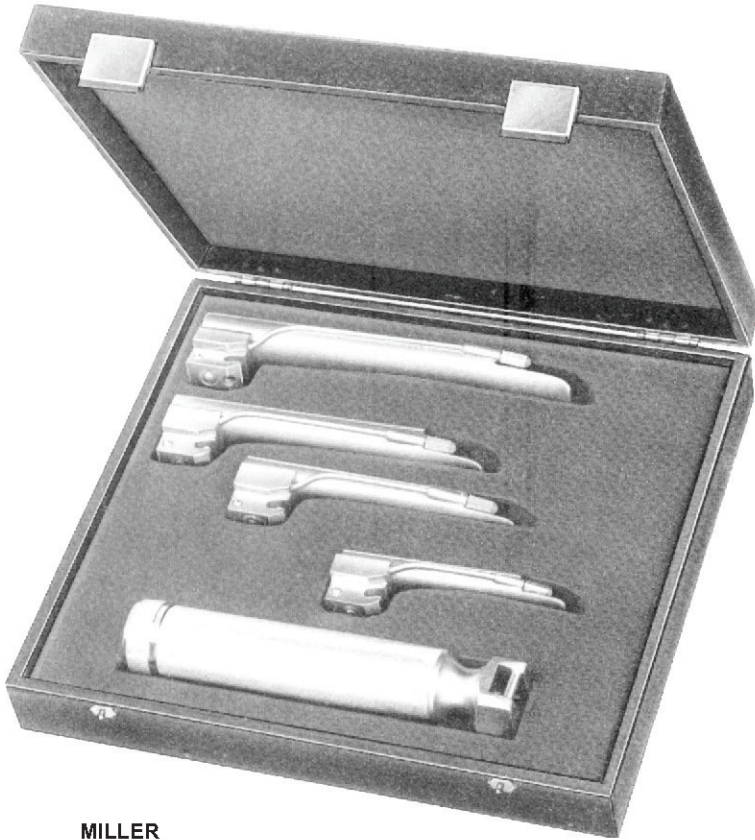


OI 03-1217-03  
Fig. 3  
for women  
170 mm



OI 03-1217-04  
Fig. 4  
for men  
180 mm





**MILLER**

OI 03-1218-00  
set with 4 blades, battery handle  
(without batteries)  
Fig. 1 to 4, in case

**MILLER-BABY**

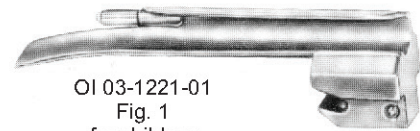
OI 03-1219-00  
set with 2 blades, battery handle  
(without batteries)  
Fig. 0 & 1, in case

**MILLER**

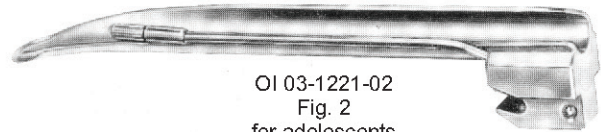
OI 03-1220-00  
set with 3 blades, battery handle  
(without batteries)  
Fig. 1 to 3, in case



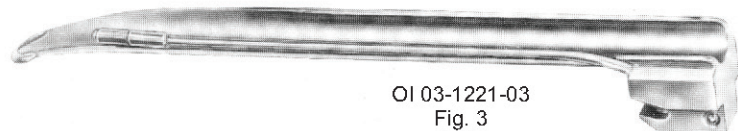
OI 03-1221-00  
Fig. 0  
for children  
55 mm



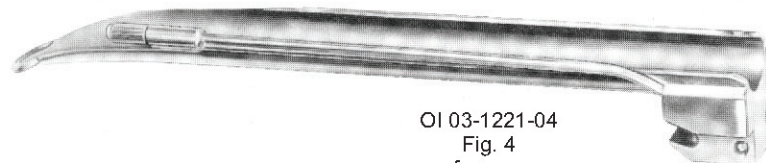
OI 03-1221-01  
Fig. 1  
for children  
80 mm



OI 03-1221-02  
Fig. 2  
for adolescents  
130 mm



OI 03-1221-03  
Fig. 3  
for women  
170 mm



OI 03-1221-04  
Fig. 4  
for men  
180 mm



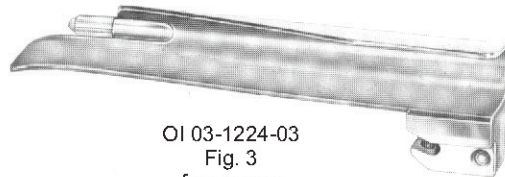
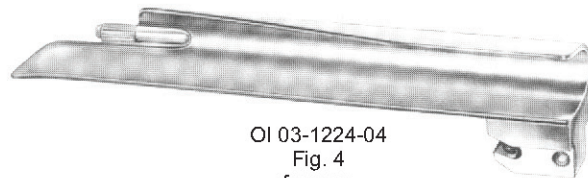

**GUEDEL-NEGUS**

 OI 03-1222-00  
 set with 4 blades  
 Fig. 1 to 4, in case

**GUEDEL-NEGUS**

 OI 03-1223-00  
 set with 3 blades  
 Fig. 2 to 4, in case

 OI 03-1224-01  
 Fig. 1  
 for children  
 70 mm

 OI 03-1224-02  
 Fig. 2  
 for adolescent  
 90 mm

 OI 03-1224-03  
 Fig. 3  
 for women  
 110 mm

 OI 03-1224-04  
 Fig. 4  
 for men  
 135 mm

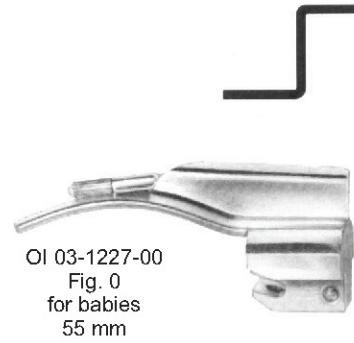




**MCINTOSH**  
 OI 03-1225-00  
 set with 3 blades  
 Fig. 1 to 3, in case



**MCINTOSH**  
 OI 03-1226-00  
 set with 4 blades  
 Fig. 1 to 4, in case



OI 03-1227-00  
 Fig. 0  
 for babies  
 55 mm



OI 03-1227-01  
 Fig. 1  
 for children  
 70 mm



OI 03-1227-02  
 Fig. 2  
 for adolescent  
 90 mm



OI 03-1227-03  
 Fig. 3  
 for women  
 110 mm



OI 03-1227-04  
 Fig. 4  
 for men  
 130 mm





fiber optic



OI 03-1228-00  
Battery handle (without batteries)  
with halogen bulb and green ring



OI 03-1229-00  
Battery handle (without batteries)  
with halogen bulb and green ring



OI 03-1230-00  
Spare bulb  
Krypton 2.5 V

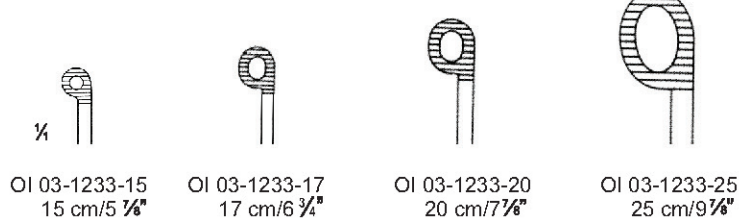


OI 03-1231-00  
Spare bulb  
Xenon 2.5 V



OI 03-1232-00  
Spare bulb  
Halogen 2.5 V





MAGILL



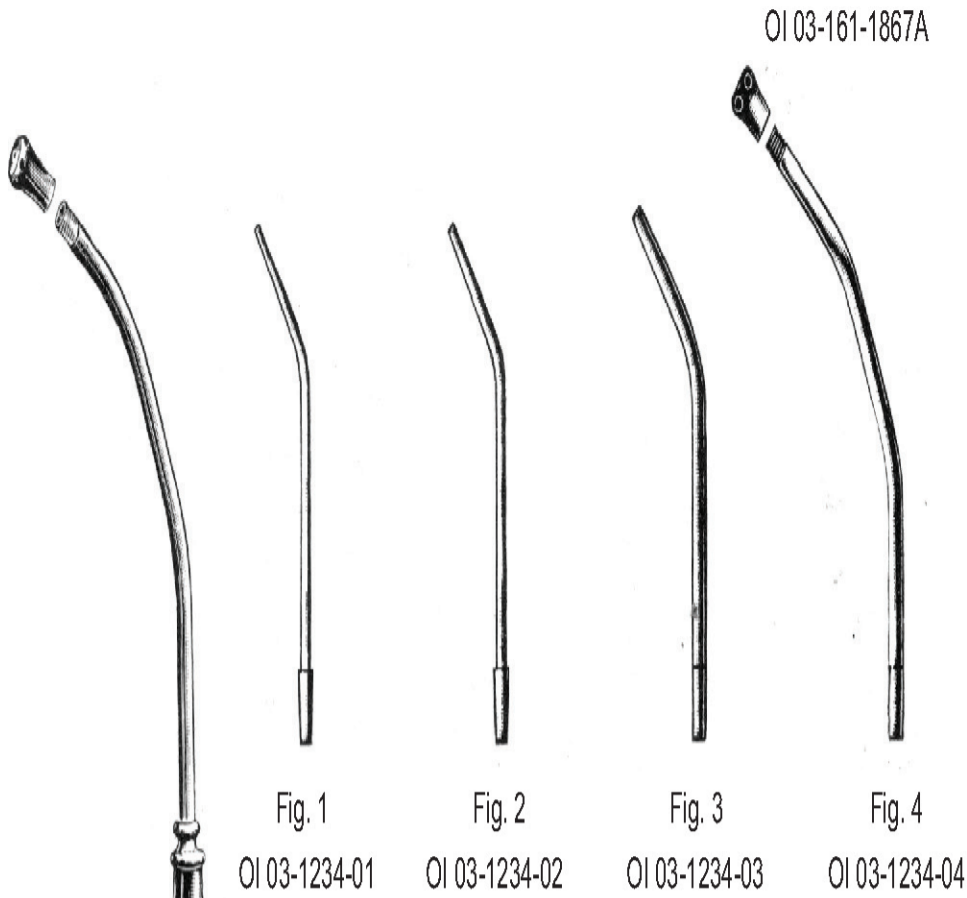
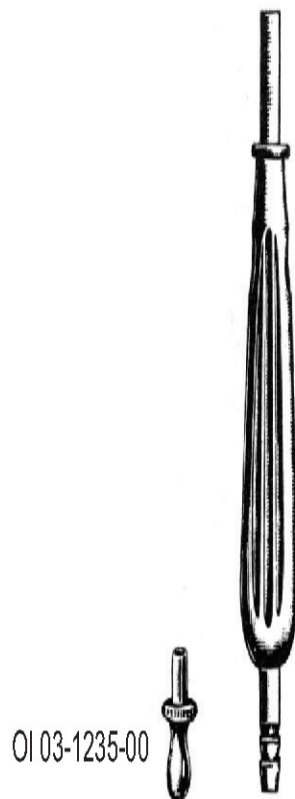


Fig. 1 OI 03-1234-01  
Fig. 2 OI 03-1234-02  
Fig. 3 OI 03-1234-03  
Fig. 4 OI 03-1234-04



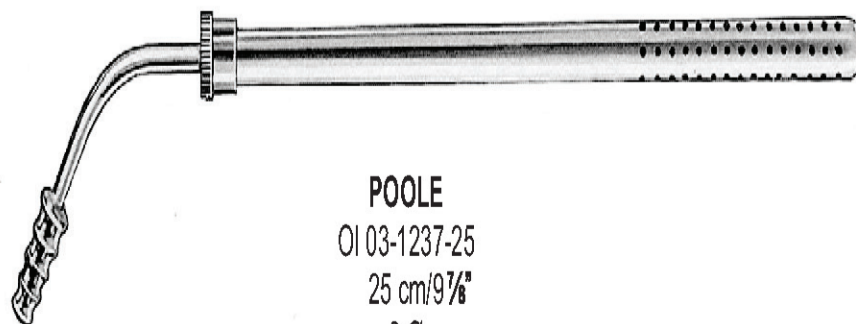
**YANKAUER**  
OI 03-1234-31  
31 cm/12 1/4"  
with suction tip & connector



OI 03-1235-00  
**YANKAUER**  
OI 03-1235-31  
(complete set)  
31 cm/12 1/4"



**POOLE**  
OI 03-1236-24  
24 cm/9 1/2"  
10 Ø



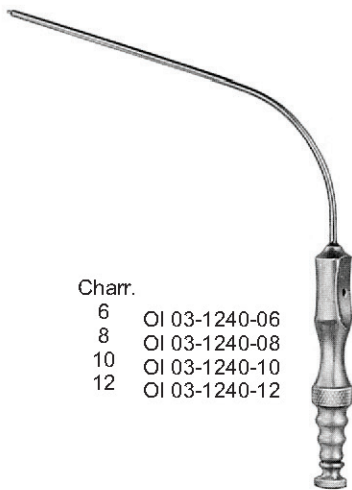
**POOLE**  
OI 03-1237-25  
25 cm/9 7/8"  
8 Ø



**ADSON**  
 OI 03-1238-21  
 21 cm/8 1/4"  
 4mm Ø



**PLESTER**  
 OI 03-1239-01 1.5mm Ø  
 OI 03-1239-02 2.0mm Ø  
 OI 03-1239-03 2.5mm Ø  
 OI 03-1239-04 3.0mm Ø  
 19.5 cm/7 3/4"



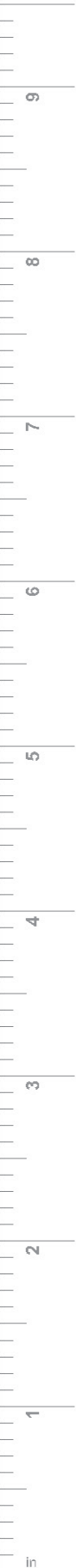
Charr.  
 6 OI 03-1240-06  
 8 OI 03-1240-08  
 10 OI 03-1240-10  
 12 OI 03-1240-12

**POPPE**  
 13 cm/5 1/8"



Charr.  
 6 OI 03-1241-06  
 7 OI 03-1241-07  
 8 OI 03-1241-08  
 9 OI 03-1241-09  
 10 OI 03-1241-10  
 11 OI 03-1241-11  
 12 OI 03-1241-12

**FRAZIER**  
 19 cm/7 1/2"

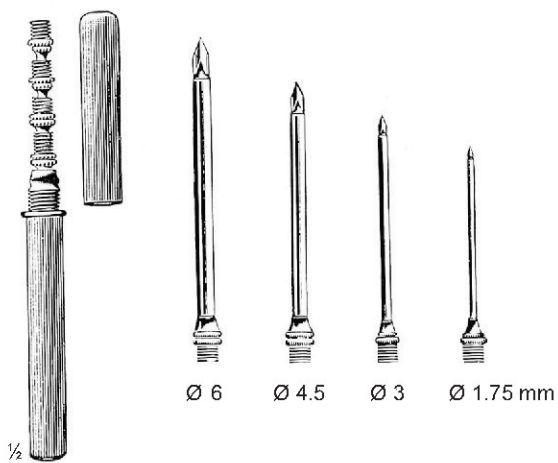




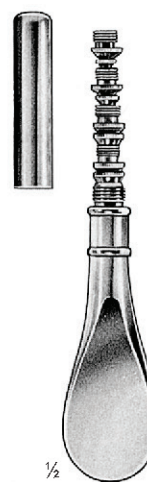
**HYDROCELE**  
OI 03-1242-08 8 Fg.  
OI 03-1242-09 9 Fg.  
OI 03-1242-10 10 Fg.



**ACITES**  
OI 03-1243-16 16 Fg.  
OI 03-1243-21 21 Fg.



**UNIVERSAL**  
OI 03-1244-30 Set of 3  
OI 03-1244-40 Set of 4

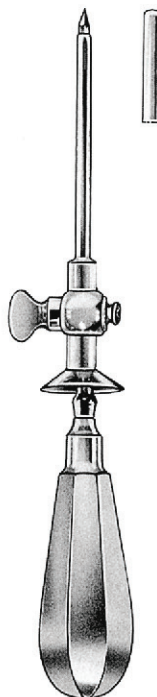


**UNIVERSAL**  
OI 03-1245-30 Set of 3  
OI 03-1245-40 Set of 4



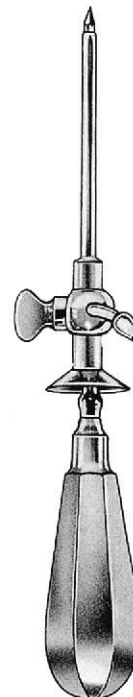
**STANDARD**

- OI 03-1246-01 Ø 3.0 mm
- OI 03-1246-02 Ø 3.5 mm
- OI 03-1246-03 Ø 4.0 mm
- OI 03-1246-04 Ø 4.5 mm
- OI 03-1246-05 Ø 5.0 mm
- OI 03-1246-06 Ø 5.5 mm
- OI 03-1246-07 Ø 6.0 mm



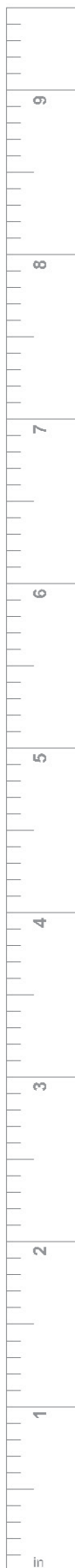
**STANDARD**

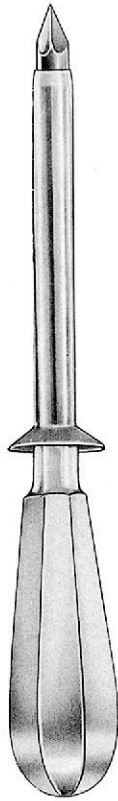
- OI 03-1247-01 Ø 3.0 mm
- OI 03-1247-02 Ø 3.5 mm
- OI 03-1247-03 Ø 4.0 mm
- OI 03-1247-04 Ø 4.5 mm
- OI 03-1247-05 Ø 5.0 mm
- OI 03-1247-06 Ø 5.5 mm
- OI 03-1247-07 Ø 6.0 mm



**STANDARD**

- OI 03-1248-01 Ø 3.0 mm
- OI 03-1248-02 Ø 3.5 mm
- OI 03-1248-03 Ø 4.0 mm
- OI 03-1248-04 Ø 4.5 mm
- OI 03-1248-05 Ø 5.0 mm
- OI 03-1248-06 Ø 5.5 mm
- OI 03-1248-07 Ø 6.0 mm





**NELSON**  
21 cm/8 1/4"



Fig. 1  
OI 03-1249-01



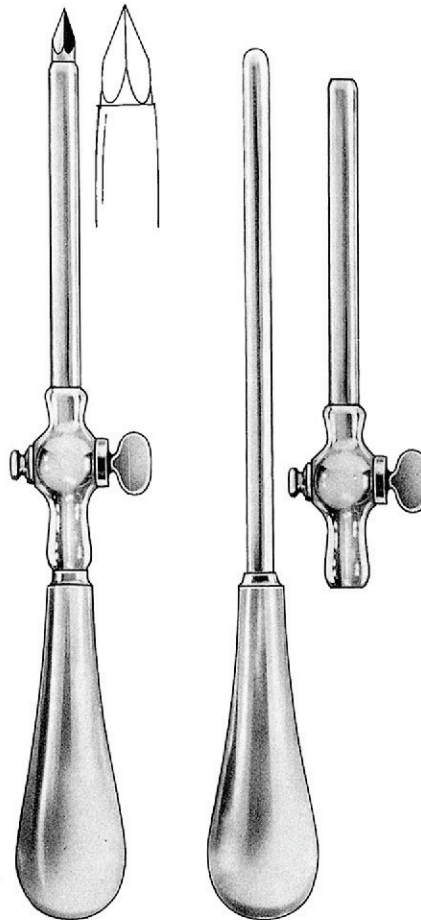
Fig. 2  
OI 03-1249-02



Fig. 3  
OI 03-1249-03

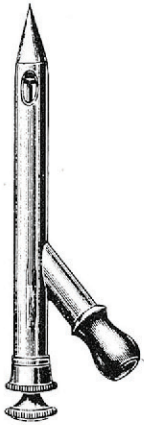


Fig. 4  
OI 03-1249-04



**BUELAU**  
OI 03-1250-24  
24 cm/9 1/2"  
8.0 mm Ø

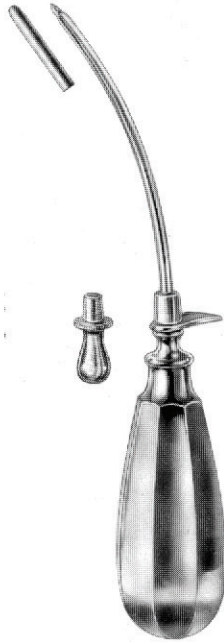




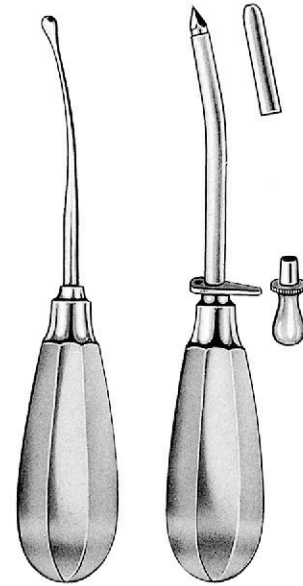
**PEAN**  
 OI 03-1251-13  
 13.5mm Ø



**OCHSNER**  
 OI 03-1252-04 4.0 mm Ø  
 OI 03-1252-05 5.5 mm Ø  
 OI 03-1252-06 6.5 mm Ø



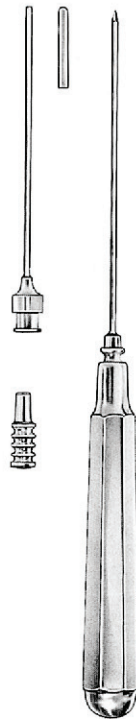
**PIERCE**  
 OI 03-1253-03 15 cm/5 7/8" 3.0 mm Ø  
 OI 03-1253-04 15 cm/5 7/8" 4.0 mm Ø  
 OI 03-1253-05 15 cm/5 7/8" 5.0 mm Ø



**KRAUSE**  
 OI 03-1254-15 15 cm/5 7/8"  
 5.5 mm Ø



**LICHTWITZ**  
 OI 03-1255-02  
 2.0 mm Ø



**LICHTWITZ**  
 OI 03-1256-19  
 19 cm/7 1/2"  
 1.8 mm Ø



**COAKLEY**  
 OI 03-1257-16  
 16 cm/6 1/4"  
 2.25 mm Ø

