

- EN** Artery Forceps
- DE** Arterienklemmen
- ES** Pinzas hemostáticas

Page 117 to 157

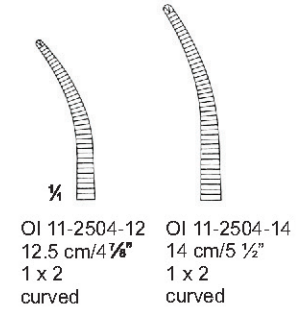

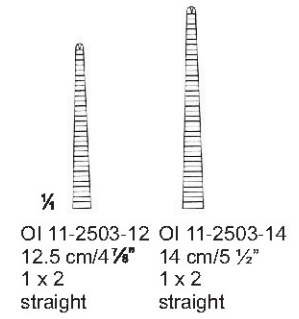
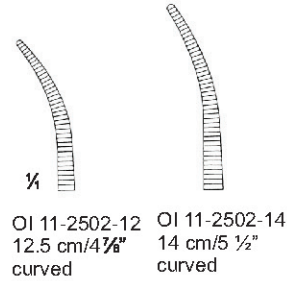
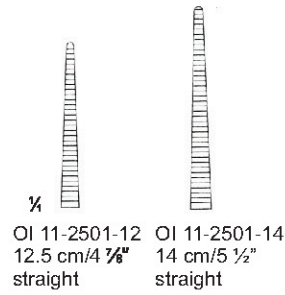

ATRAUMA

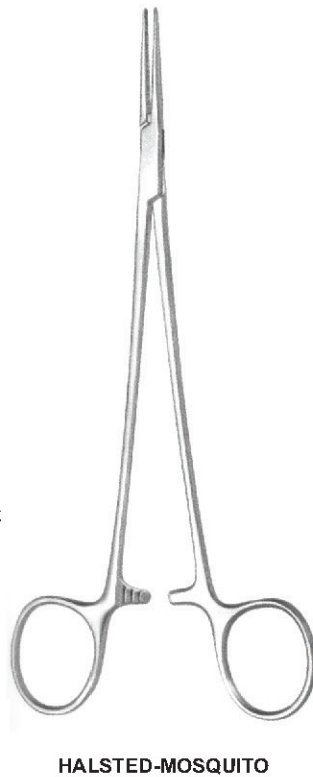
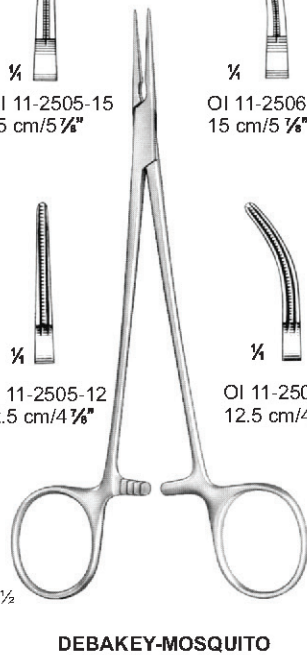
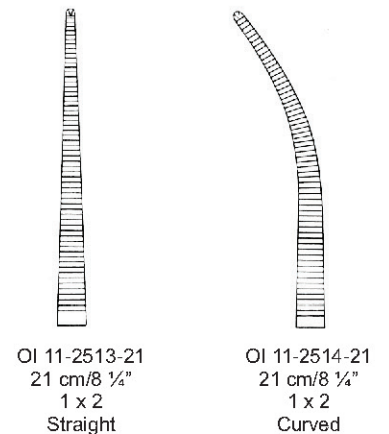
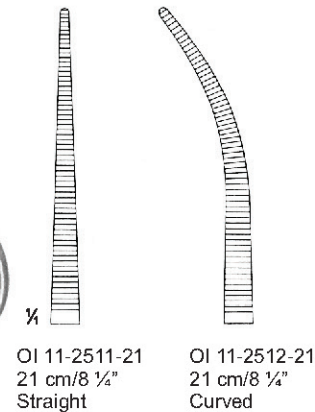
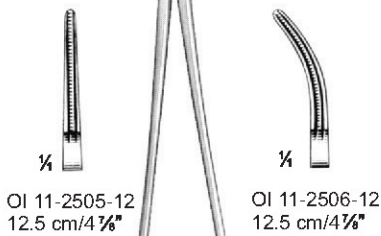
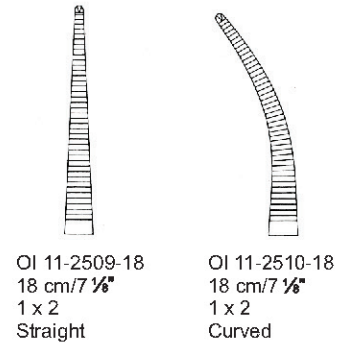
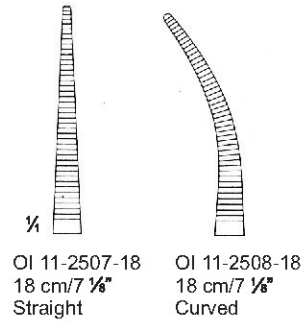
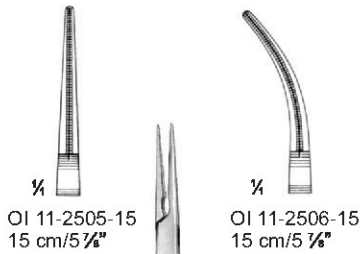

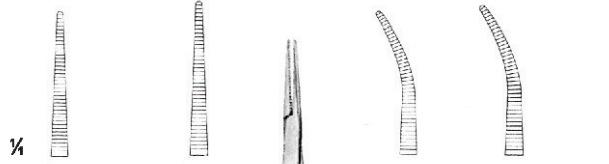

OI 11-2515-10 10 cm/3 7/8" OI 11-2515-12 12 cm/4 3/4"
 OI 11-2516-10 10 cm/3 7/8" OI 11-2516-12 12 cm/4 3/4"

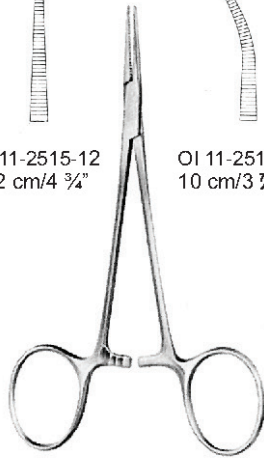

MICRO-MOSQUITO



OI 11-2517-10 10 cm/3 7/8" 1 : 2 OI 11-2517-12 12 cm/4 3/4" 1 : 2 Teeth
 OI 11-2518-10 10 cm/3 7/8" 1 : 2 OI 11-2518-12 12 cm/4 3/4" 1 : 2 Teeth

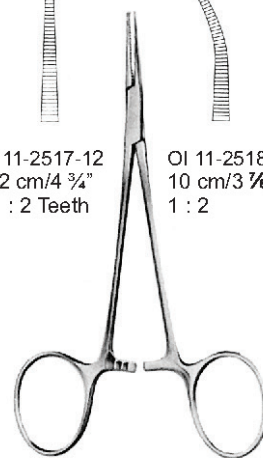

MICRO-MOSQUITO

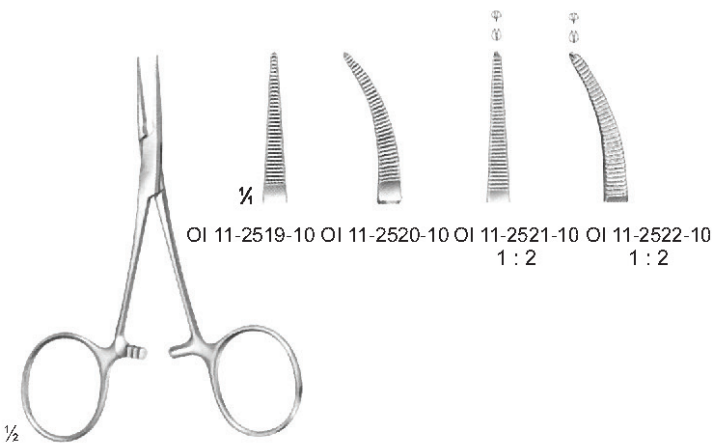

OI 11-2519-10 1 : 2 OI 11-2520-10 1 : 2
 OI 11-2521-10 1 : 2 OI 11-2522-10 1 : 2

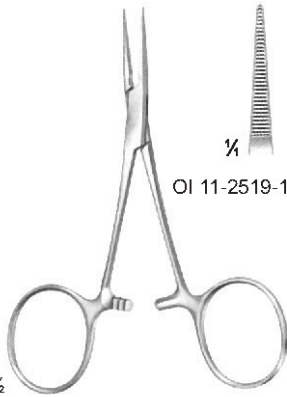

**HARTMANN
 (BABY-MOSQUITO)**
 10 cm/3 7/8"



CARREL
 OI 11-2523-08
 8.5 cm/3 3/8"

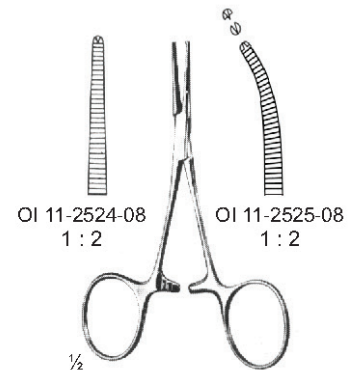

OI 11-2524-08 1 : 2 OI 11-2525-08 1 : 2

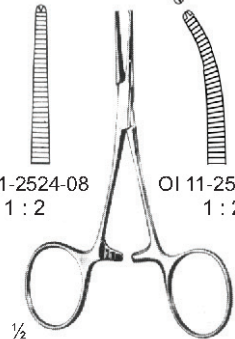

TERRIER
 8.5 cm/3 3/8"



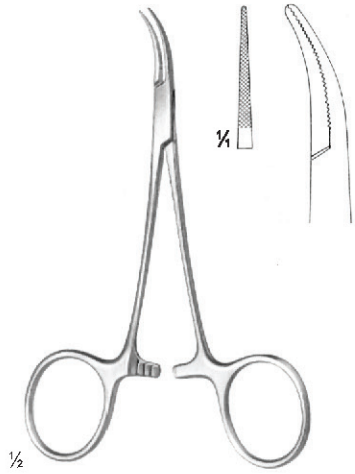

MOSQUITO-DANDY
OI 11-2526-12
12 cm/4 3/4"



DANDY
14 cm/5 1/2"

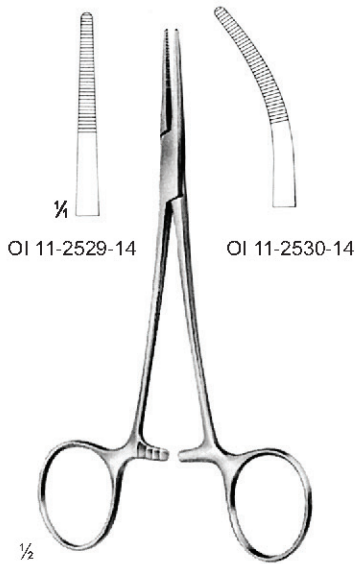
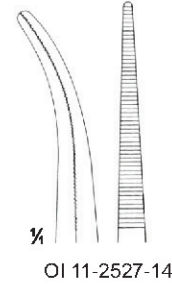

PROVIDENCE-HOSPITAL
14 cm/5 1/2"

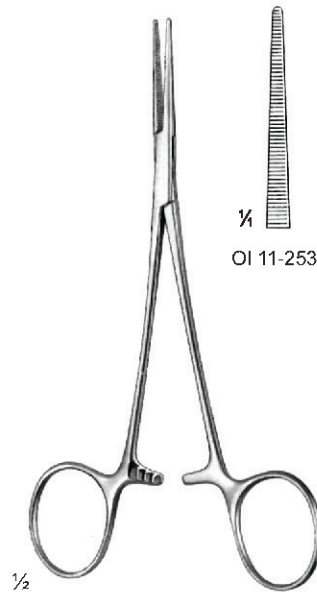

LERICHE
15 cm/5 7/8"

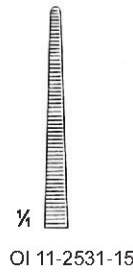



KELLY
 14 cm/5 1/2"

KELLY-RANKIN
 16 cm/6 1/4"

BABY-OVERHOLT
 OI 11-2539-13
 13.5 cm/5 3/8"

CRILE
 14 cm/5 1/2"

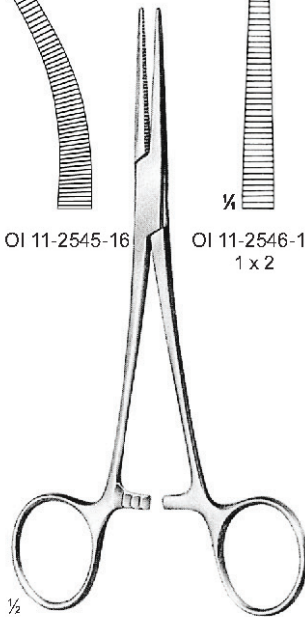
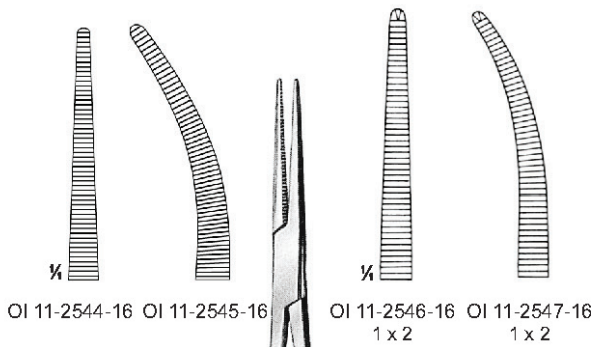

CRILE RANKIN
 16 cm/6 1/4"

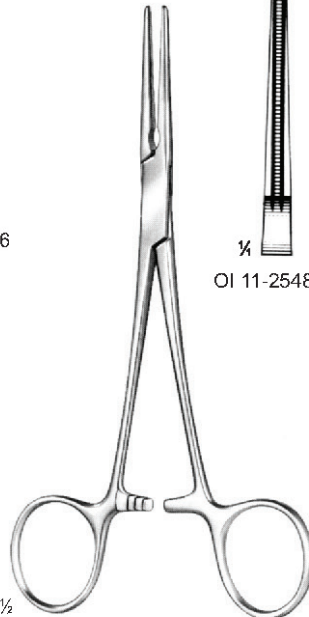

DEBAKEY-RANKIN
 16 cm/6 1/4"

ATRAUMA

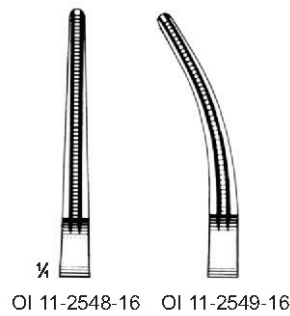

CROSS SERRATIONS

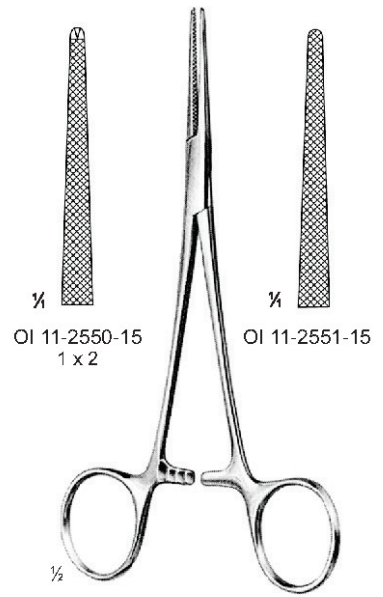

LOVELACE
 15.5 cm/6 1/8"





SPENCER-WELLS/JONES



OI 11-2552-13
13 cm/5 1/8"



OI 11-2552-14
14.5 cm/5 3/4"



OI 11-2552-15
15.5 cm/6 1/8"

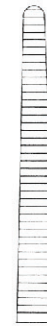

OI 11-2552-18
18.5 cm/7 1/4"



OI 11-2552-20
20 cm/7 7/8"



OI 11-2553-13
13 cm/5 1/8"



OI 11-2553-14
14 cm/5 1/2"



OI 11-2553-15
15 cm/5 7/8"



OI 11-2553-18
18 cm/7 1/8"



OI 11-2553-20
20 cm/7 7/8"



OI 11-2554-13
13.5 cm/5 3/8"



OI 11-2554-14
14.5 cm/5 3/4"



OI 11-2554-17
17 cm/6 3/4"



OI 11-2555-13
13 cm/5 1/8"



OI 11-2555-14
14 cm/5 1/2"



OI 11-2555-16
16.5 cm/6 1/2"

Cm	In	Straight
18	7 1/8"	OI 11-2557-18
20	7 7/8"	OI 11-2557-20
22	8 1/2"	OI 11-2557-22
24	9 1/2"	OI 11-2557-24
26	10 1/4"	OI 11-2557-26
28	11"	OI 11-2557-28

Cm	In	Curved
18	7 1/8"	OI 11-2558-18
20	7 7/8"	OI 11-2558-20
22	8 1/2"	OI 11-2558-22
24	9 1/2"	OI 11-2558-24
26	10 1/4"	OI 11-2558-26
28	11"	OI 11-2558-28

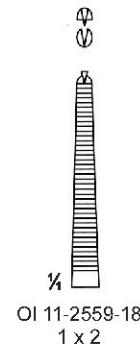

OI 11-2559-18
1 x 2

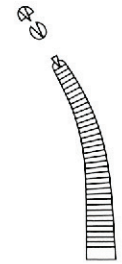

OI 11-2560-18
1 x 2

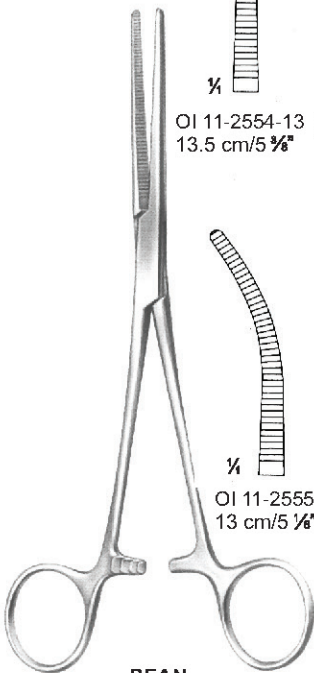

PEAN
DELICATE PATTERN

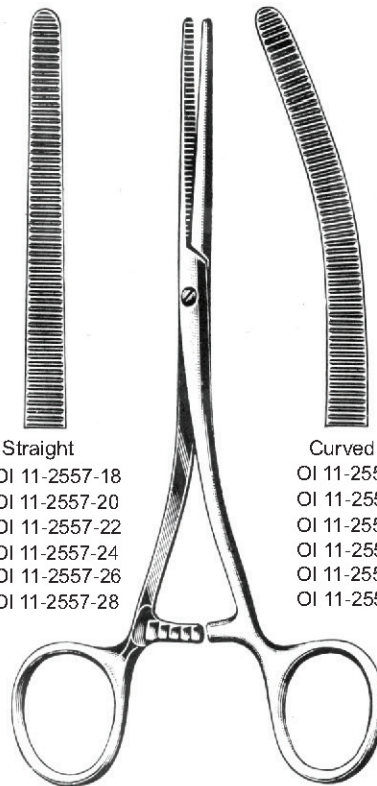

PEAN

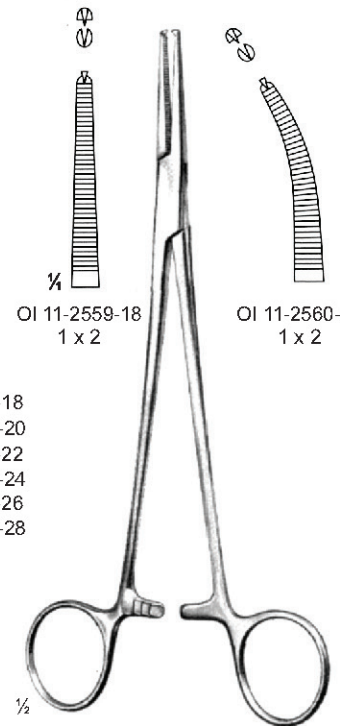

ADSON
18.5 cm/7 1/4"



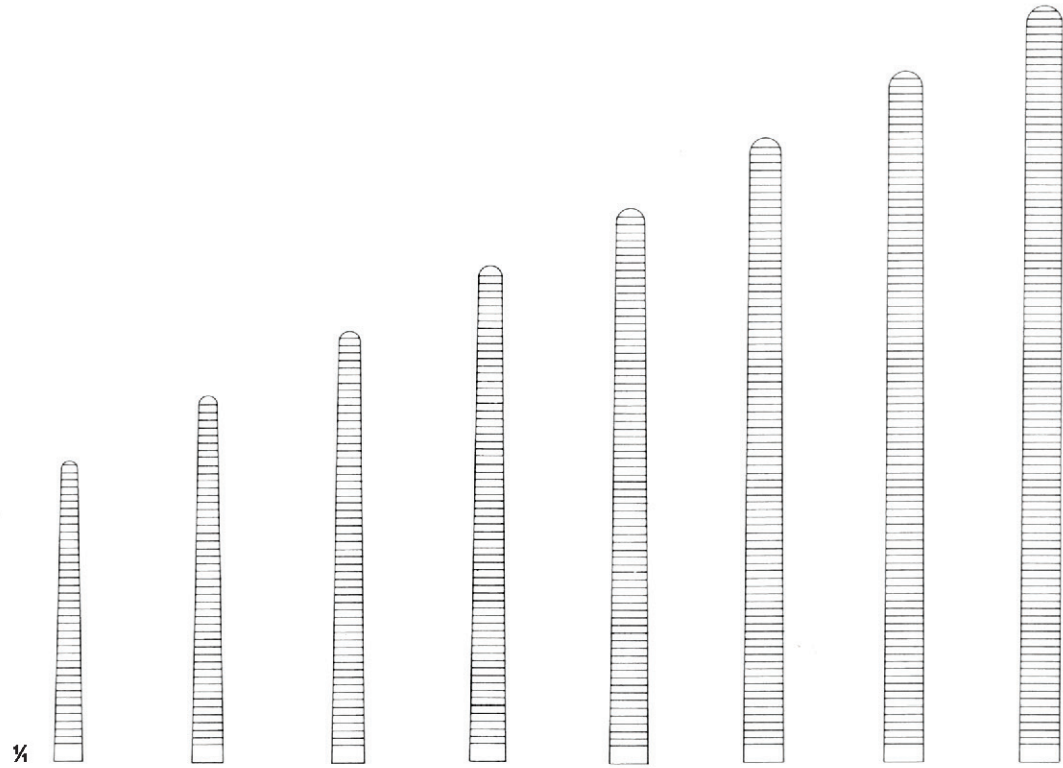

OI 11-2561-14 14.5 cm/5 3/4" OI 11-2561-16 16.5 cm/6 1/2" OI 11-2561-18 18.5 cm/7 1/4" OI 11-2561-20 20.5 cm/8 1/8" OI 11-2561-22 22.5 cm/8 3/4" OI 11-2561-24 24.5 cm/9 5/8" OI 11-2561-26 26 cm/10 1/4" OI 11-2561-30 30.5 cm/12"



ROCHESTER-PEAN

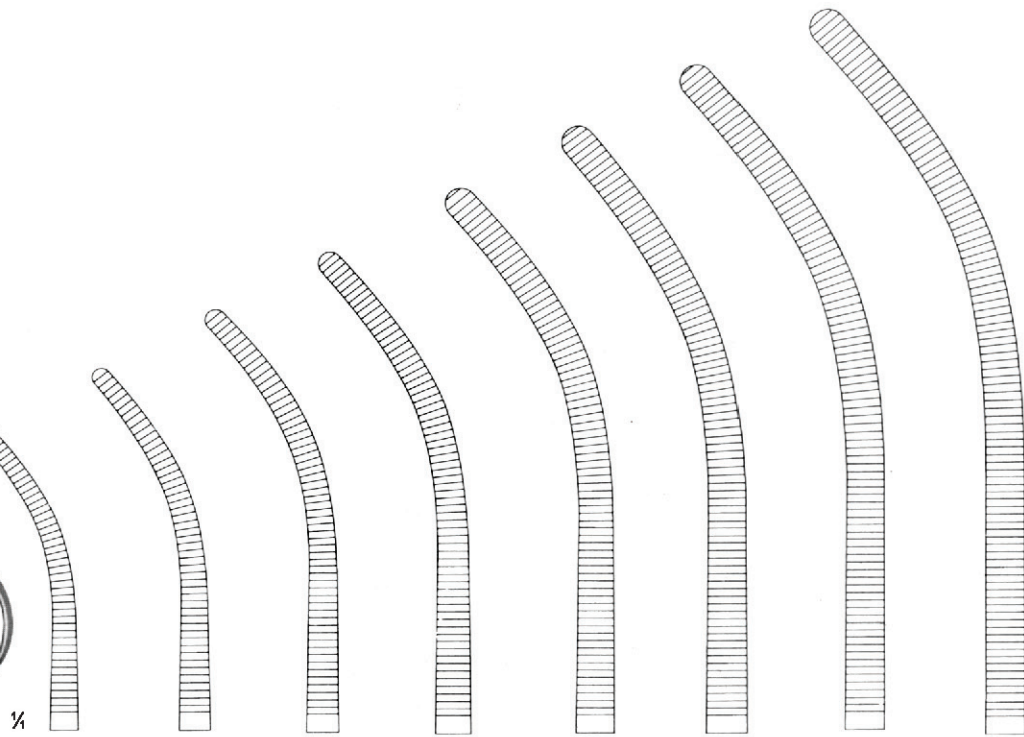

OI 11-2562-14 14.5 cm/5 3/4" OI 11-2562-16 16.5 cm/6 1/2" OI 11-2562-18 18.5 cm/7 1/4" OI 11-2562-20 20.5 cm/8 1/8" OI 11-2562-22 22.5 cm/8 3/4" OI 11-2562-24 24.5 cm/9 5/8" OI 11-2562-26 26 cm/10 1/4" OI 11-2562-30 30.5 cm/12"





ATRAUMA

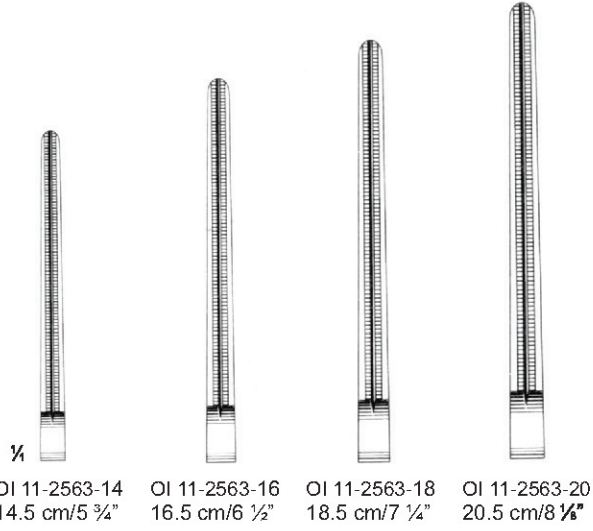

DEBAKEY-PEAN

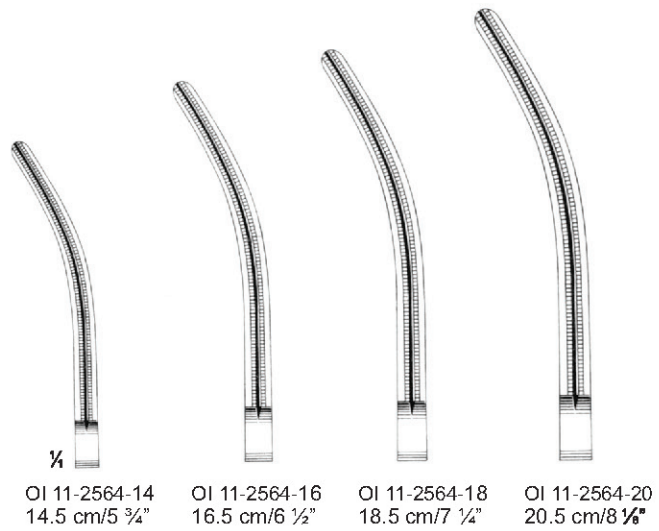

DEBAKEY-PEAN

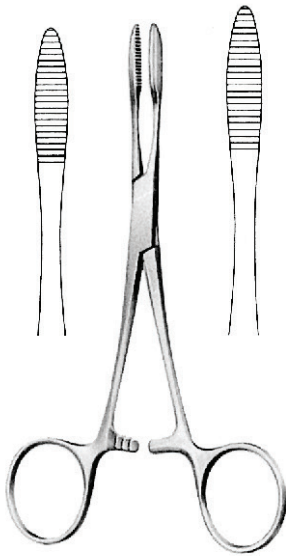

PEAN
OI 11-2565-14 14 cm/5 1/2"
OI 11-2565-16 16 cm/6 1/4"



KOCHER
Delicate Pattern
1 : 2

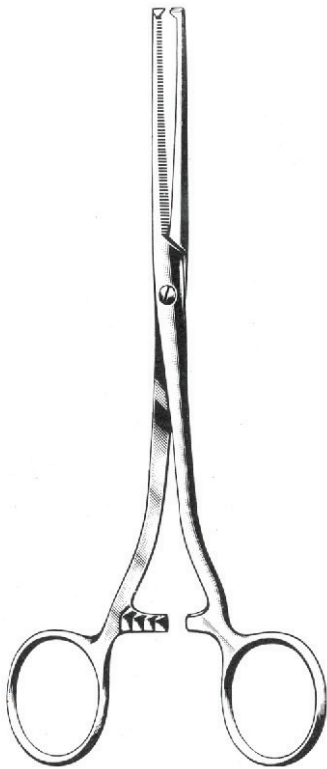
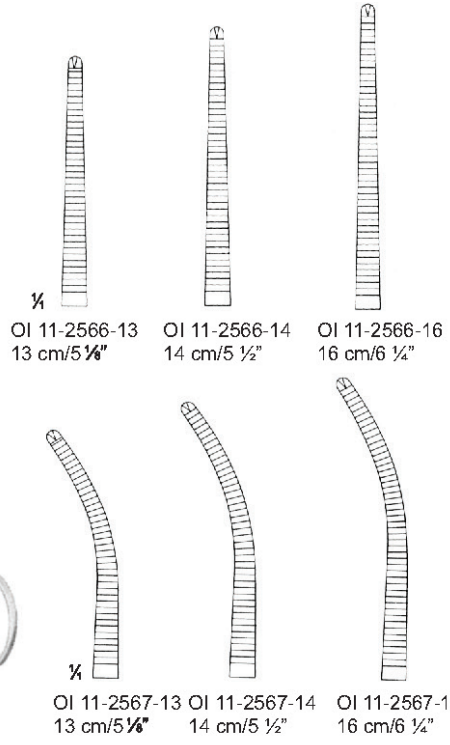

KOCHER

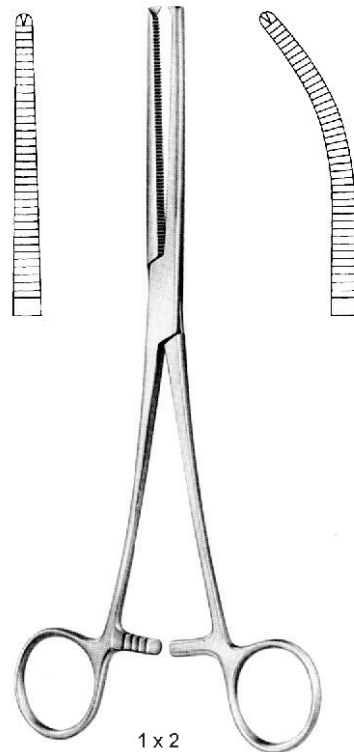
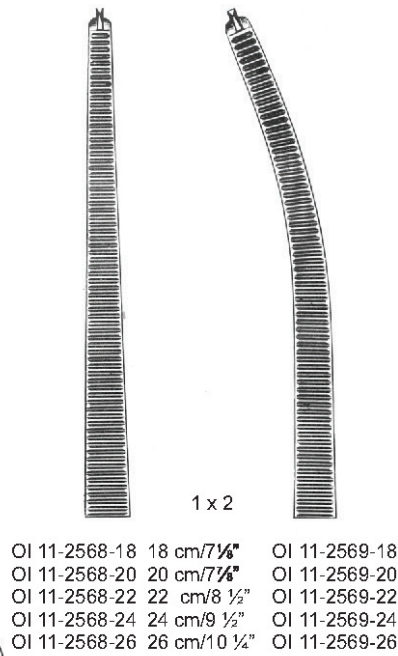

KOCHER (STANDARD)

OI 11-2570-13 13 cm/5 1/8"
OI 11-2570-14 14 cm/5 1/2"
OI 11-2571-14 14.5cm/5 3/4"

OI 11-2572-13
OI 11-2572-14
OI 11-2573-14



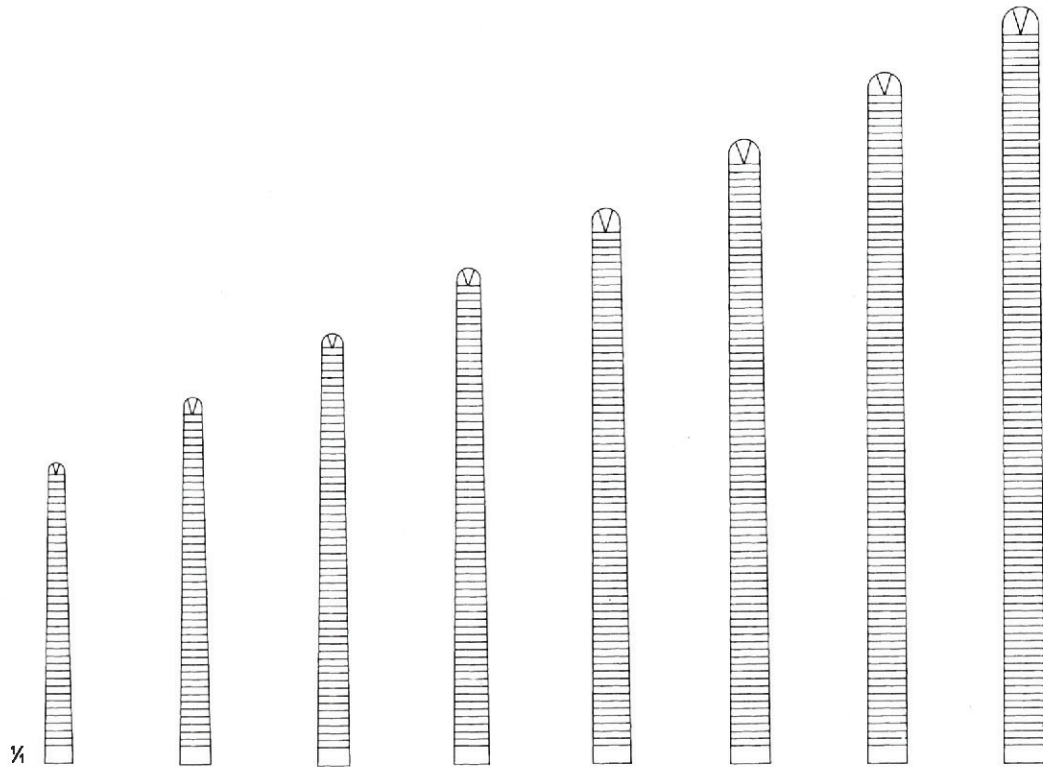

OI 11-2574-16 16 cm/6 1/4" OI 11-2574-18 18 cm/7 1/8" OI 11-2574-20 20 cm/7 7/8" OI 11-2574-22 22 cm/8 1/2" OI 11-2574-24 24 cm/9 1/2" OI 11-2574-26 26 cm/10 1/4" OI 11-2574-28 28 cm/11" OI 11-2574-30 30 cm/11 3/4"



KOCHER OCHSNER
1 : 2

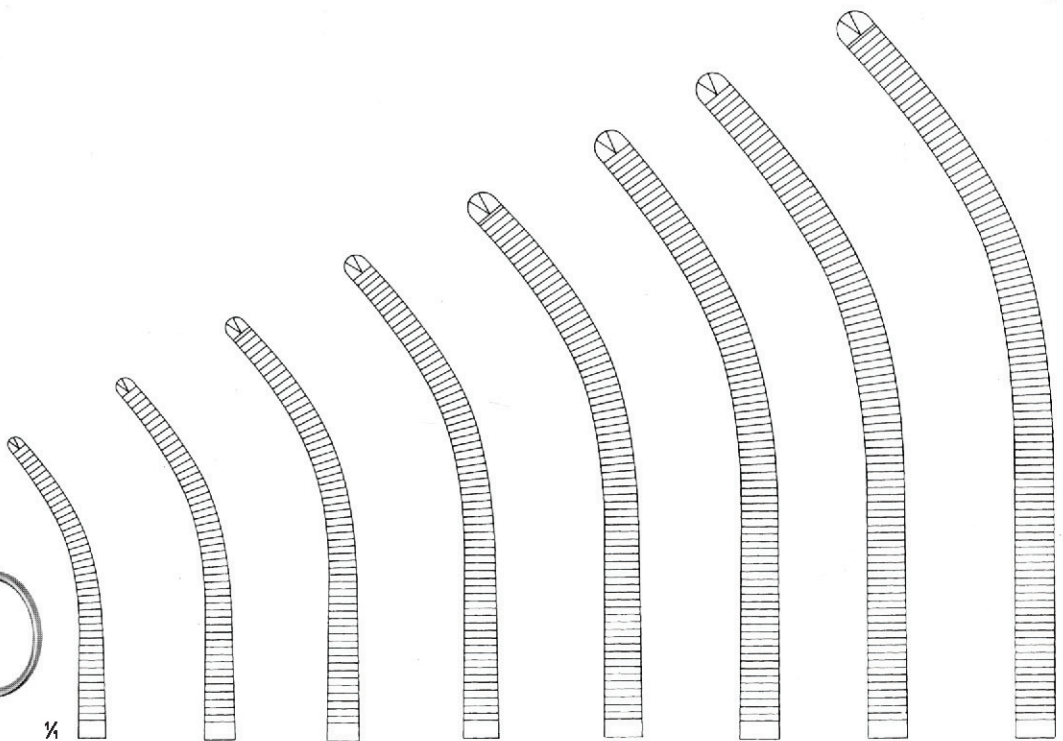

OI 11-2575-16 16 cm/6 1/4" OI 11-2575-18 18 cm/7 1/8" OI 11-2575-20 20 cm/7 7/8" OI 11-2575-22 22 cm/8 1/2" OI 11-2575-24 24 cm/9 1/2" OI 11-2575-26 26 cm/10 1/4" OI 11-2575-28 28 cm/11" OI 11-2575-30 30 cm/11 3/4"

ARTERY FORCEPS

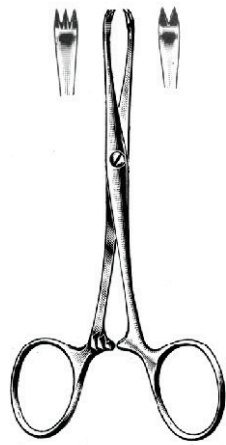

CHAPUT
 OI 11-2576-13
 13 cm/5 1/8"

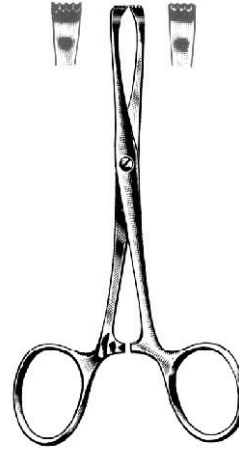

TUFFIER
 OI 11-2577-13
 13 cm/5 1/8"

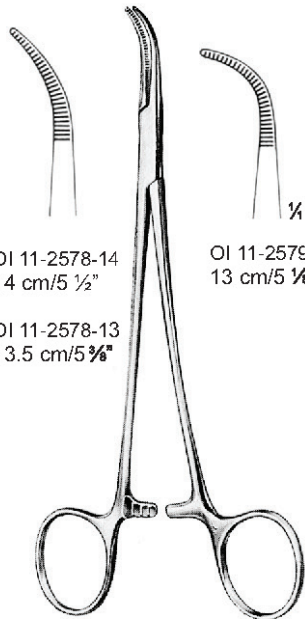

OI 11-2578-14
 14 cm/5 1/2"

OI 11-2578-13
 13.5 cm/5 3/8"

BABY-MIXTER

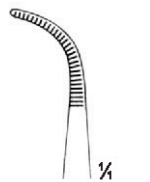

OI 11-2579-13
 13 cm/5 1/8"

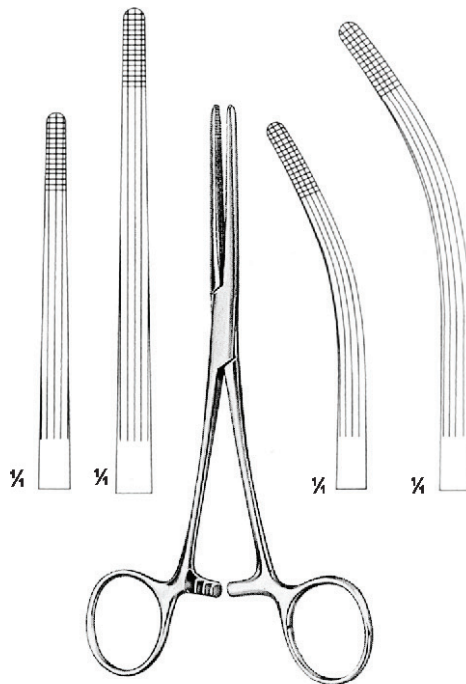

ROCHESTER-CARMALT
 OI 11-2580-16 16 cm/6 1/4" OI 11-2581-16
 OI 11-2580-20 20 cm/7 7/8" OI 11-2581-20

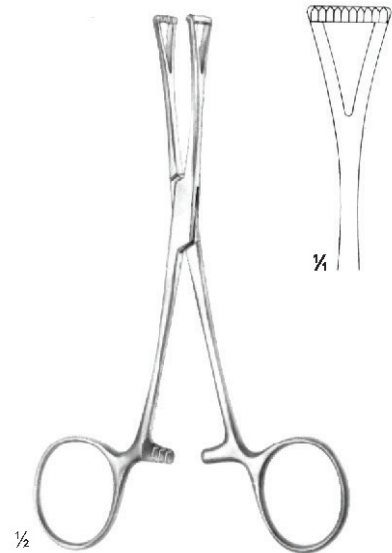

COLLIN
 OI 11-2582-14
 14 cm/5 1/2"

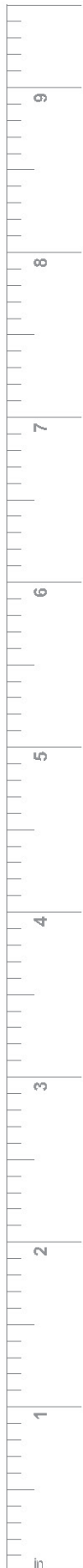



BIRKET
18.5 cm / 7 1/4"

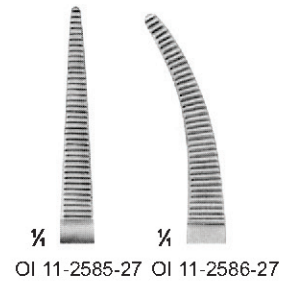
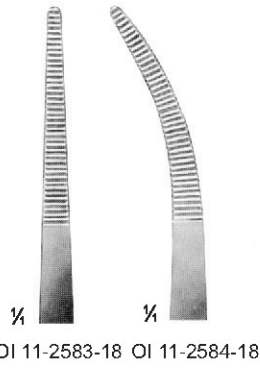

BENGOLEA

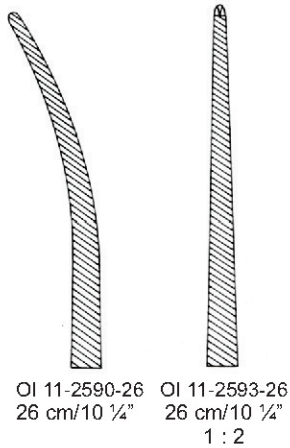
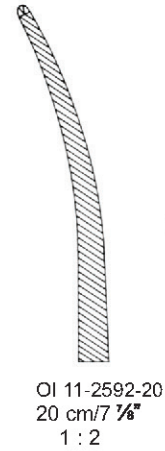
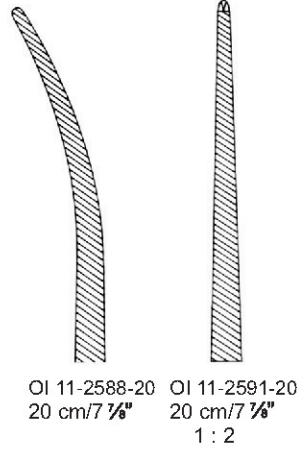
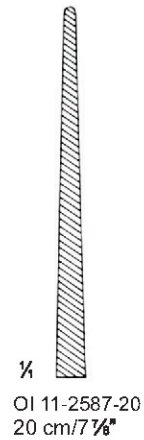

BRIDGE
27.5 cm / 10 3/4"



ARTERY FORCEPS

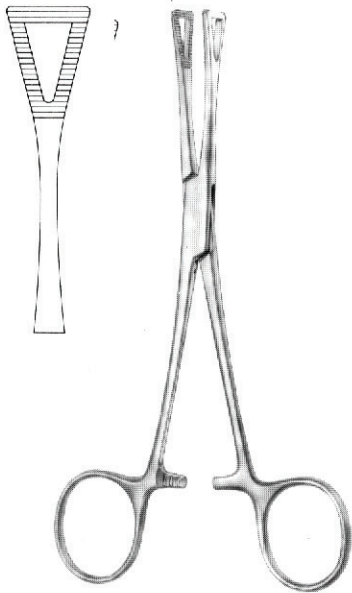

PENNINGTON

OI 11-2595-15 15.5 cm/6 1/8"
OI 11-2595-20 20 cm/7 7/8"

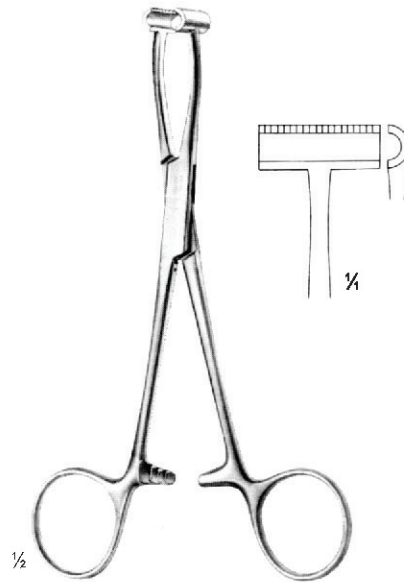

PRATT

OI 11-2596-15
15 cm/5 7/8"

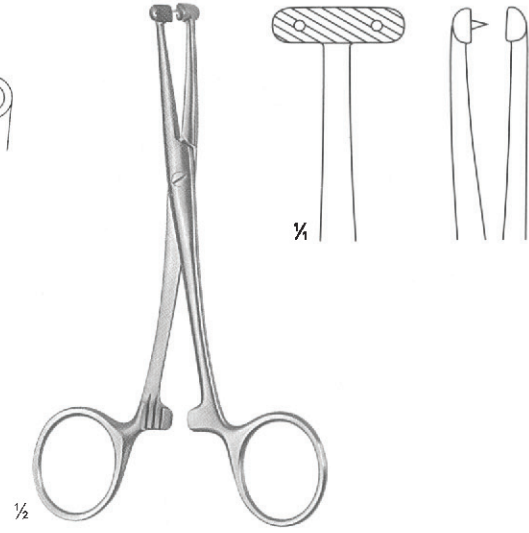

MARTEL

OI 11-2597-14
14 cm/5 1/2"



WILLET-MARTEL

OI 11-2598-19
19 cm/7 1/2"

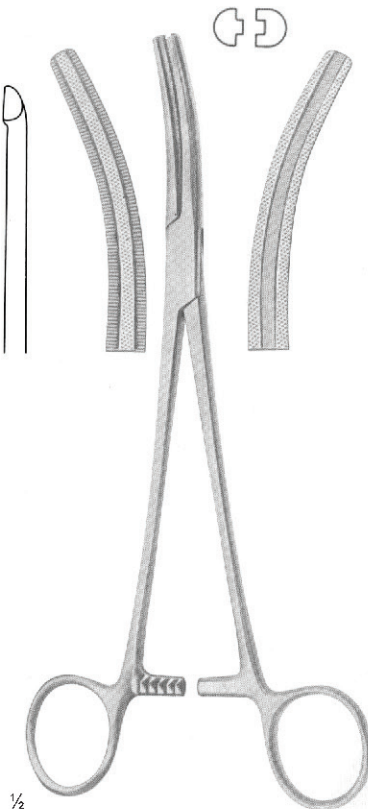

BUIE

OI 11-2599-21
21 cm/8 1/4"

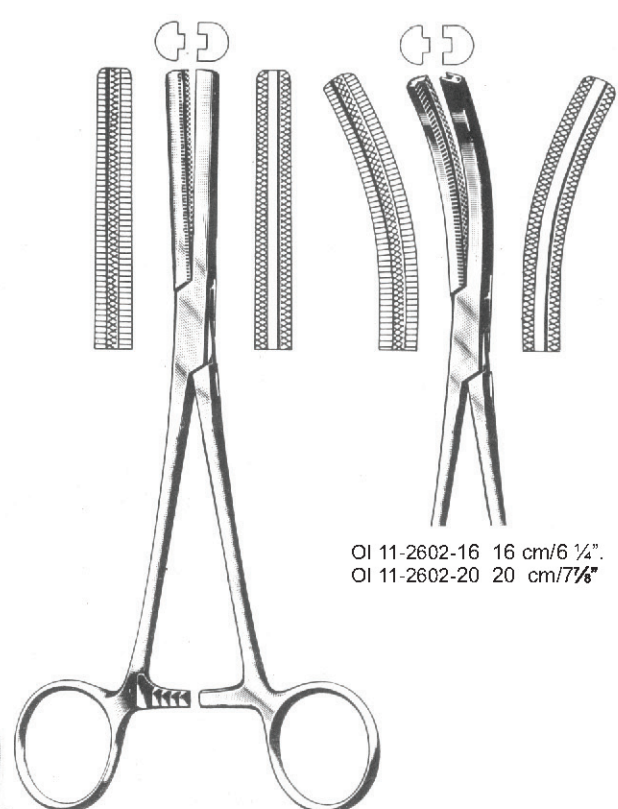

FERGUSSON

OI 11-2600-16 16 cm/6 1/4"
OI 11-2600-20 20 cm/7 7/8"

OI 11-2602-16 16 cm/6 1/4"
OI 11-2602-20 20 cm/7 7/8"



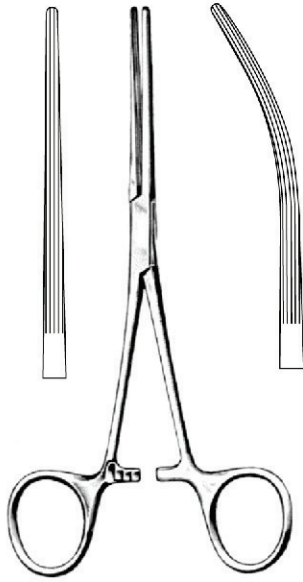

BAINBRIDGE

OI 11-2603-15 15 cm/5 7/8" OI 11-2604-15
 OI 11-2603-18 18.5 cm/7 1/4" OI 11-2604-18

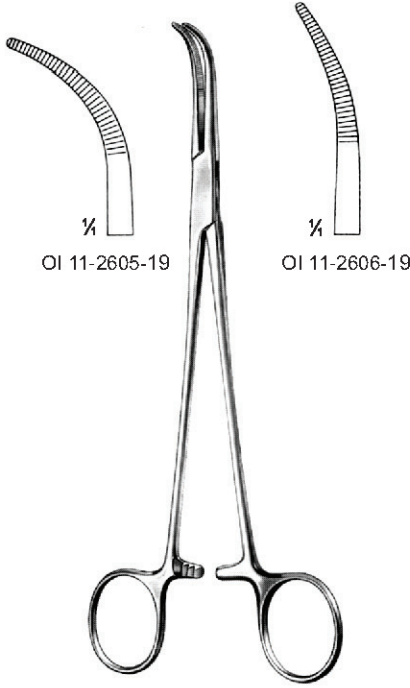

SCHNIDT

19 cm/7 1/2"

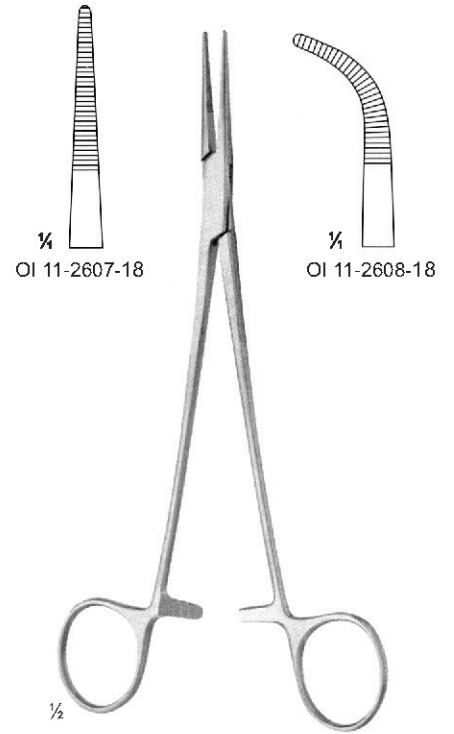

ADSON

18.5 cm/7 1/4"

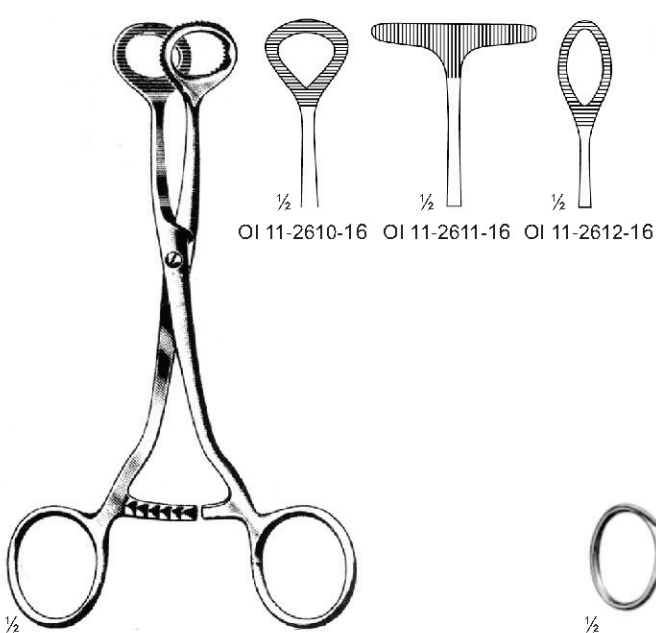

COLLIN

OI 11-2609-16
 16 cm/6 1/4"

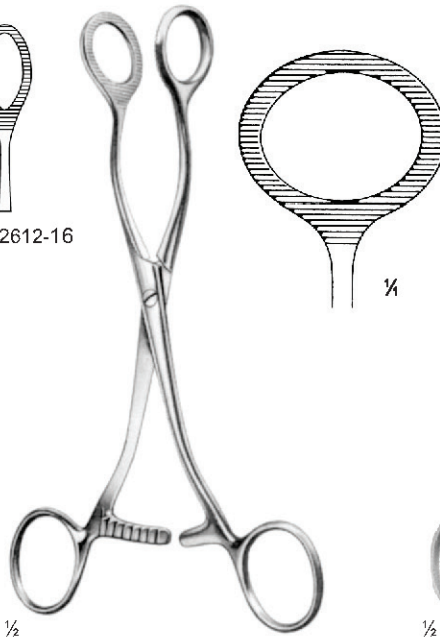

COLLIN

OI 11-2613-16
 16.5 cm/6 1/2"

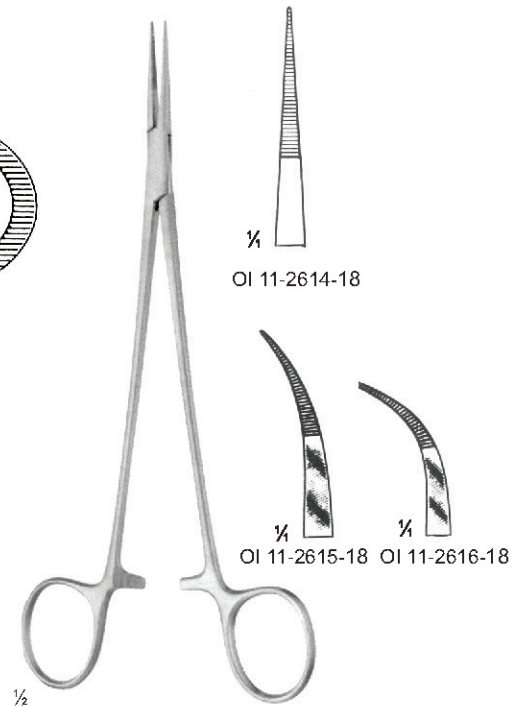

JACOBSON-MICRO

18 cm/7 1/8"



ARTERY FORCEPS



BABY-MIXTER
 OI 11-2617-18
 18 cm/7 1/8"



MICRO-ADSON
 OI 11-2618-14
 14 cm/5 1/2"

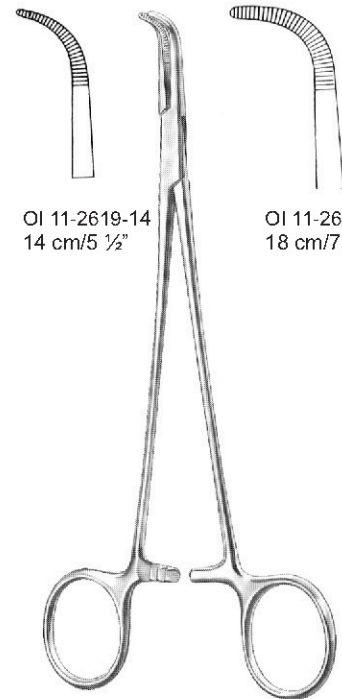

OI 11-2619-14
 14 cm/5 1/2"

OI 11-2619-18
 18 cm/7 1/8"

ADSON-BABY

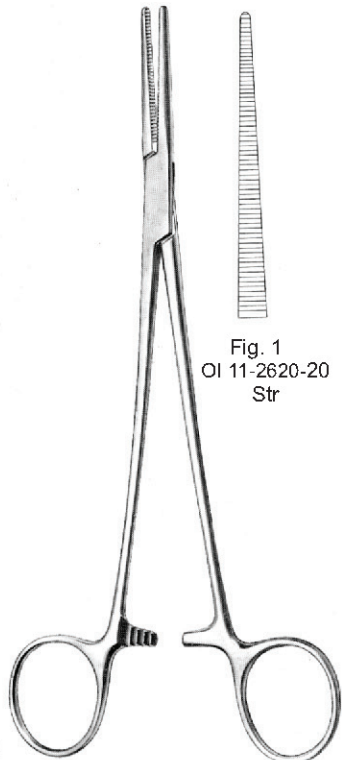

HEISS
 20 cm/7 7/8"

Fig. 1
 OI 11-2620-20
 Str

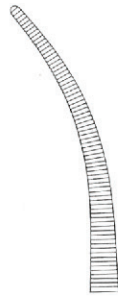
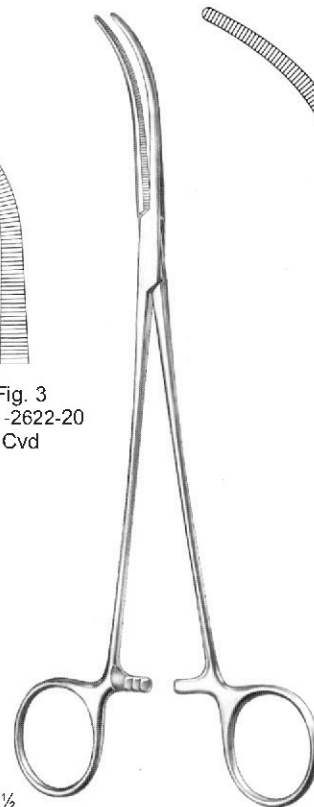

Fig. 2
 OI 11-2621-20
 Slightly Cvd



Fig. 3
 OI 11-2622-20
 Cvd



OVERHOLT-MIXTER
 OI 11-2623-21
 21 cm/8 1/4"



OI 11-2624-22

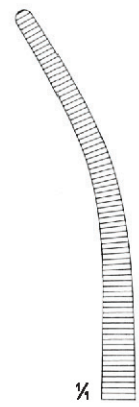

OI 11-2625-22

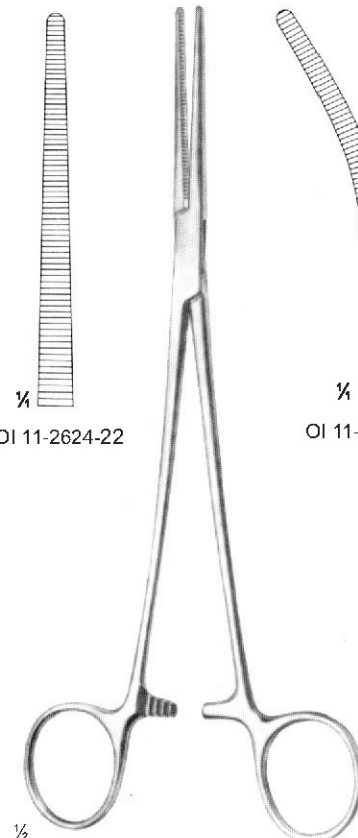

ROBERTS
 22 cm/8 1/2"



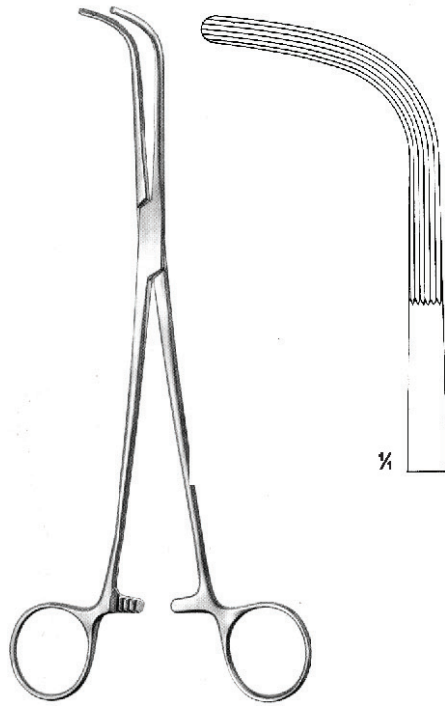

MCQUIGG-MIXTER
 OI 11-2626-23
 23.5 cm/9 1/4"

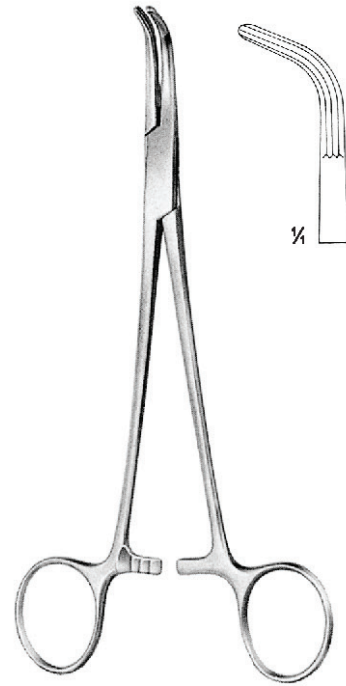

LAHEY
 OI 11-2627-18
 18.5 cm/7 1/4"



LAHEY



OI 11-2628-19
 19.5 cm/7 1/2"

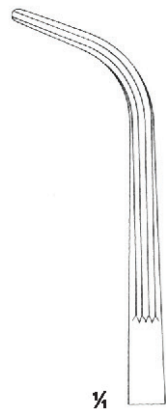

OI 11-2629-22
 22.5 cm/8 3/4"

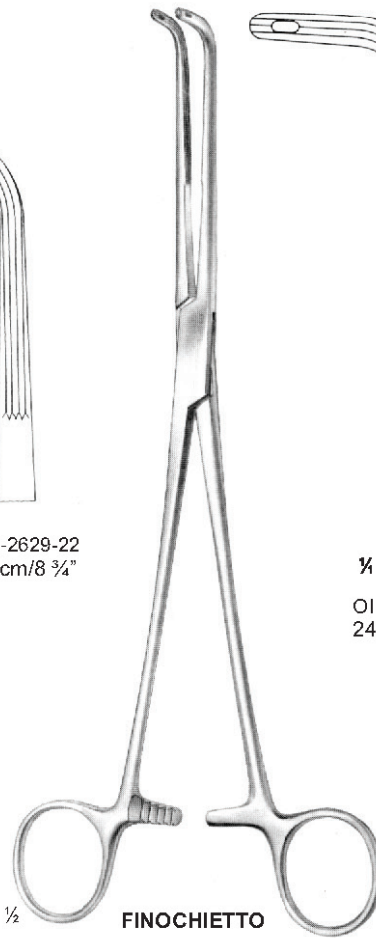

FINOCHIETTO



OI 11-2630-24
 24.5 cm/9 5/8"

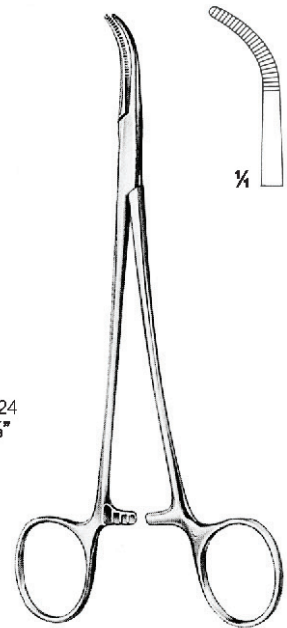

MIXTER-BABY
 OI 11-2631-14
 14 cm/5 1/2"

ARTERY FORCEPS



KELLY



Fig. 1
 OI 11-2632-19
 19 cm/7 1/2"



Fig. 1
 OI 11-2632-22
 22.5 cm/8 3/4"



Fig. 1
 OI 11-2632-24
 24.5 cm/9 5/8"



Fig. 2
 OI 11-2633-19
 19 cm/7 1/2"



Fig. 2
 OI 11-2633-22
 22 cm/8 1/2"



Fig. 2
 OI 11-2633-23
 23.5 cm/9 1/4"



Fig. 3
 OI 11-2634-18
 18.5 cm/7 1/4"



Fig. 3
 OI 11-2634-21
 21.5 cm/8 1/2"

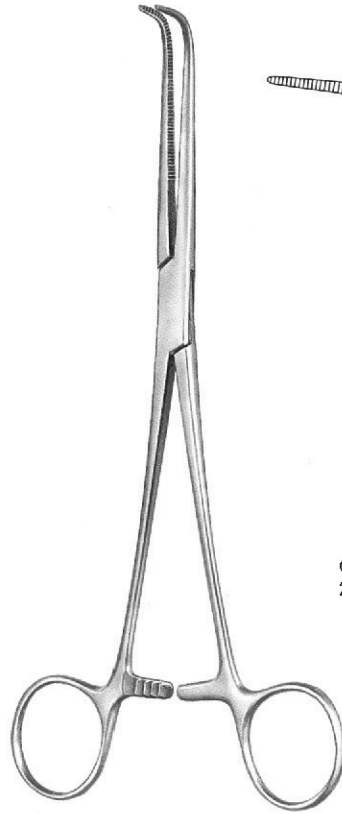

Fig. 3
 OI 11-2634-23
 23.5 cm/9 1/4"





LAWRENCE
 OI 11-2635-28
 28 cm/11"



WIKSTROEM

OI 11-2636-21
 21 cm/8 1/4"

OI 11-2636-24
 24.5 cm/9 5/8"



MEEKER
 OI 11-2637-28
 28 cm/11"

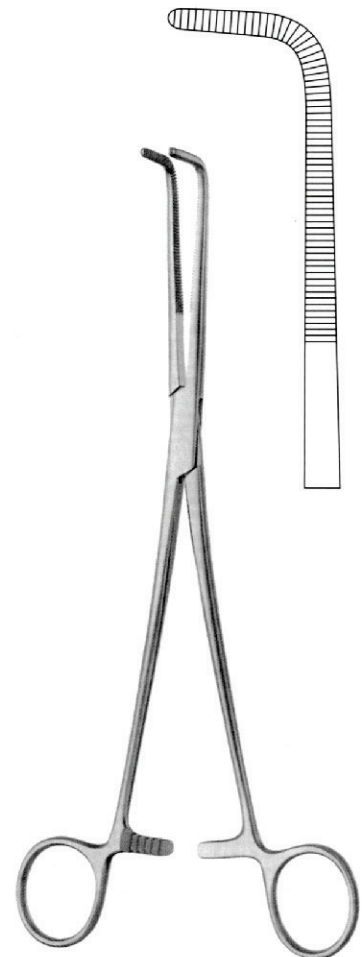

MIXTER-CRAFOORD
 OI 11-2638-25 25 cm/9 7/8"
 OI 11-2638-27 27 cm/10 1/2"



MINI-GEMINI

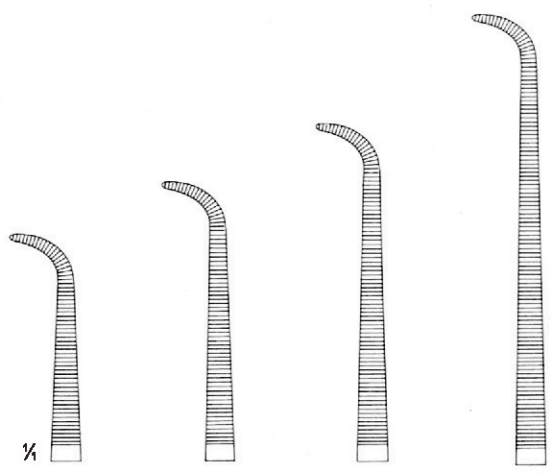

- OI 11-2639-18 18 cm/7 1/8"
- OI 11-2639-22 22.5 cm/8 3/4"
- OI 11-2639-25 25 cm/9 7/8"
- OI 11-2639-28 28.5 cm/11 1/4"



GEMINI

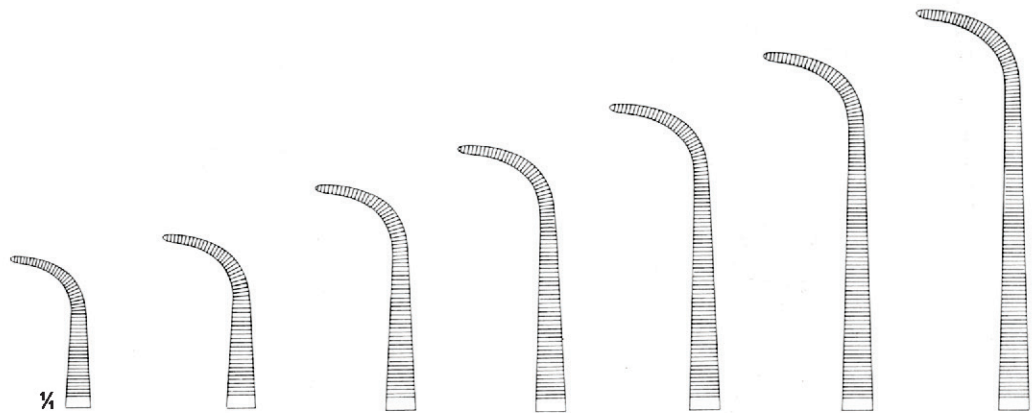

- OI 11-2640-13 13 cm/5 1/8"
- OI 11-2640-16 16 cm/6 1/4"
- OI 11-2640-18 18 cm/7 1/8"
- OI 11-2640-21 21 cm/8 1/4"
- OI 11-2640-23 23 cm/9"
- OI 11-2640-25 25 cm/9 7/8"
- OI 11-2640-28 28 cm/11"



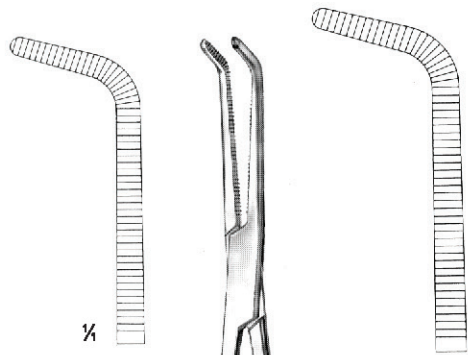

¼

MIXTER

OI 11-2641-14 14.5 cm/5 ¾"
 OI 11-2641-15 15.5 cm/6 ¼"
 OI 11-2641-19 19 cm/7 ½"

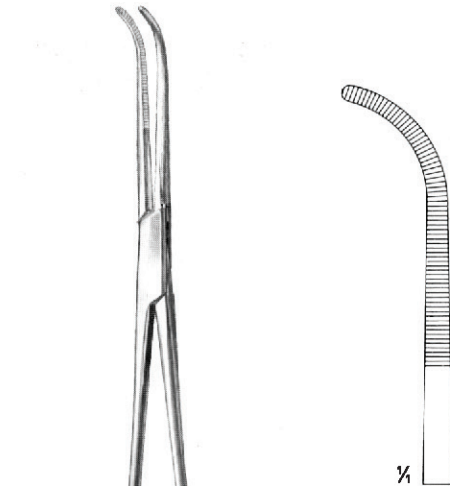

¼

½

MIXTER

OI 11-2642-22
 22 cm/8 ½"

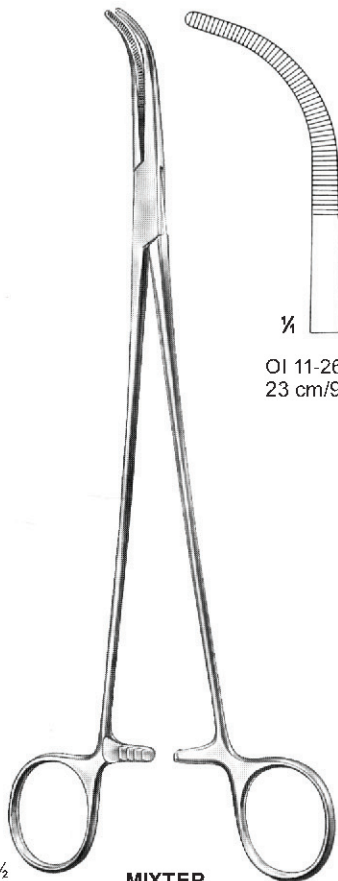

¼

OI 11-2643-23
 23 cm/9"

½

MIXTER

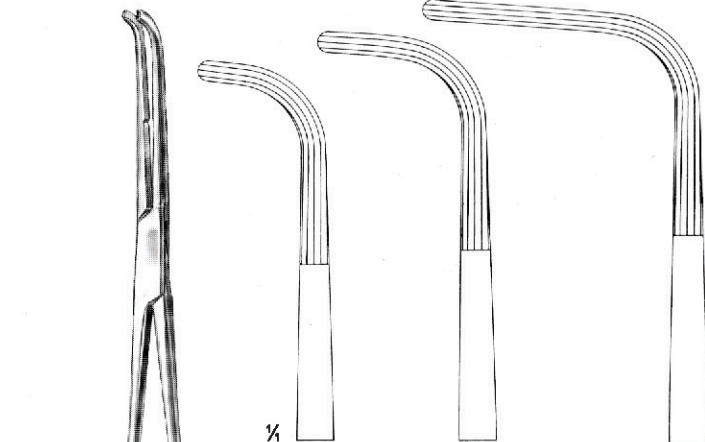

¼

Fig. 1

OI 11-2644-22
 22 cm/8 ½"

2

OI 11-2644-25
 25 cm/9 7/8"

3

OI 11-2644-28
 28 cm/11"

MIXTER



O'SHAUGNESSY



OI 11-2645-15
15 cm/5 7/8"



OI 11-2645-18
18 cm/7 1/4"



OI 11-2645-19
18.5 cm/7 1/4"



OI 11-2645-20
20 cm/7 7/8"

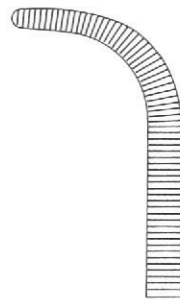

OI 11-2645-23
23 cm/9"



OI 11-2645-26
26 cm/10 1/4"



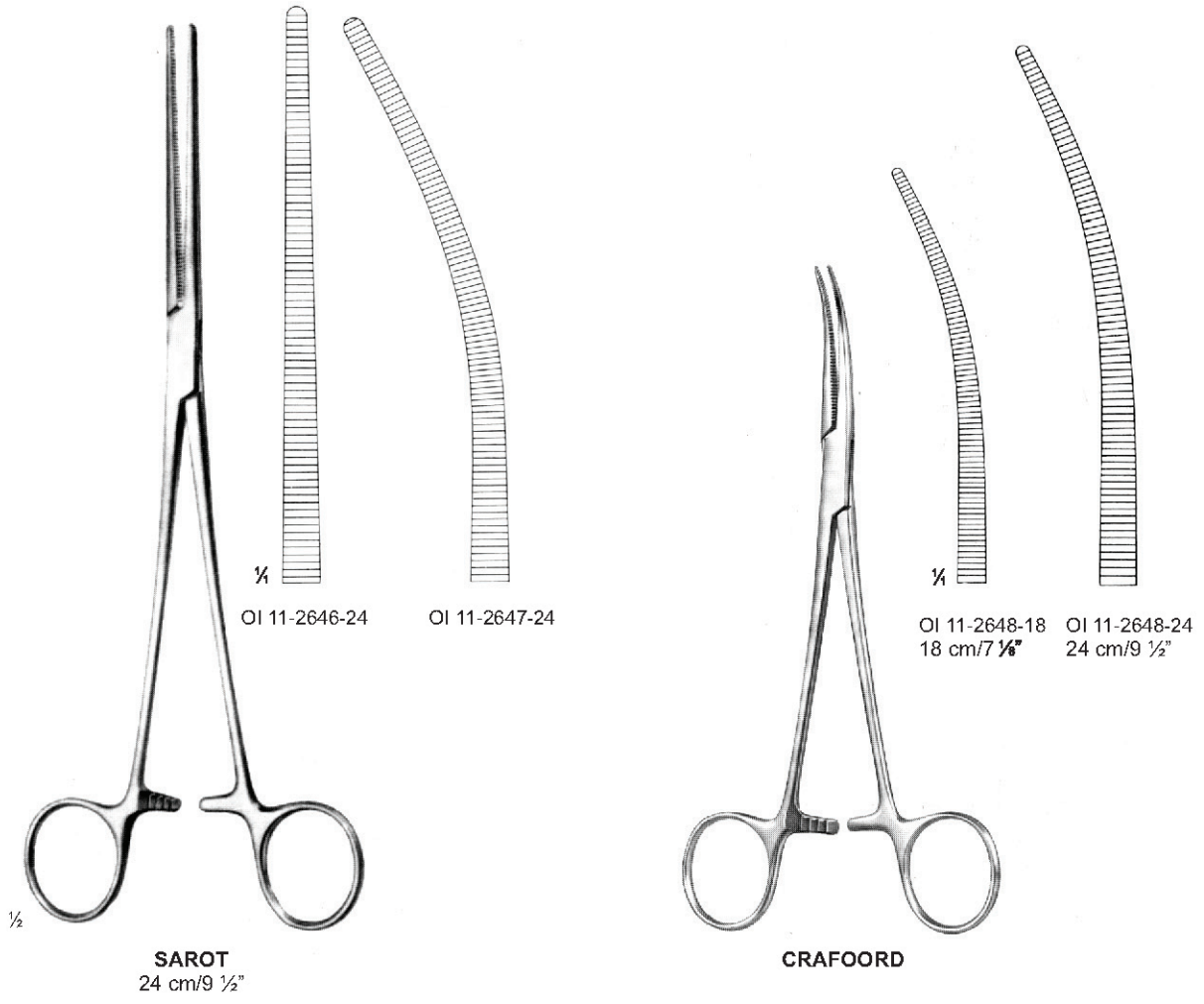

ARTERY FORCEPS



CRAFOORD-SELLORS
 24 cm/9 1/2"
 Vascular Clamp

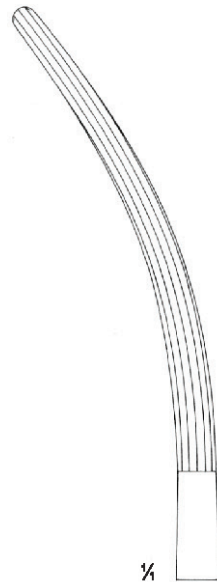

1/4
 OI 11-2649-24

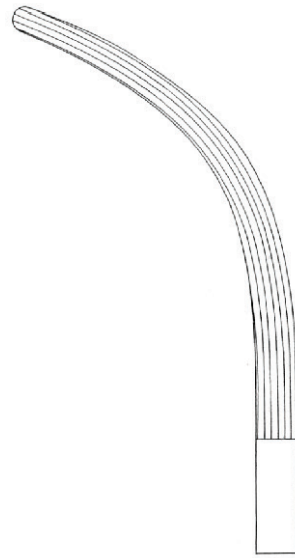

OI 11-2650-24

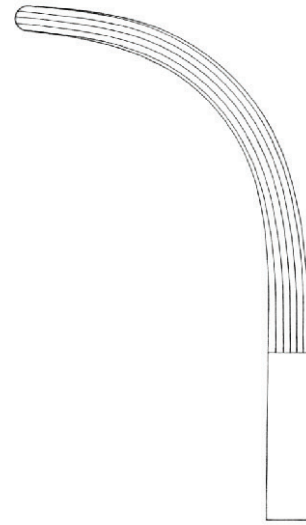

OI 11-2651-24



JOHNS HOPKINS
 OI 11-2652-20
 20 cm/7 7/8"

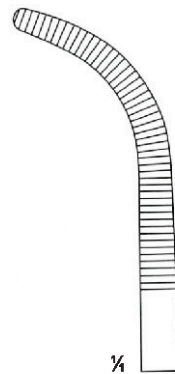

1/4

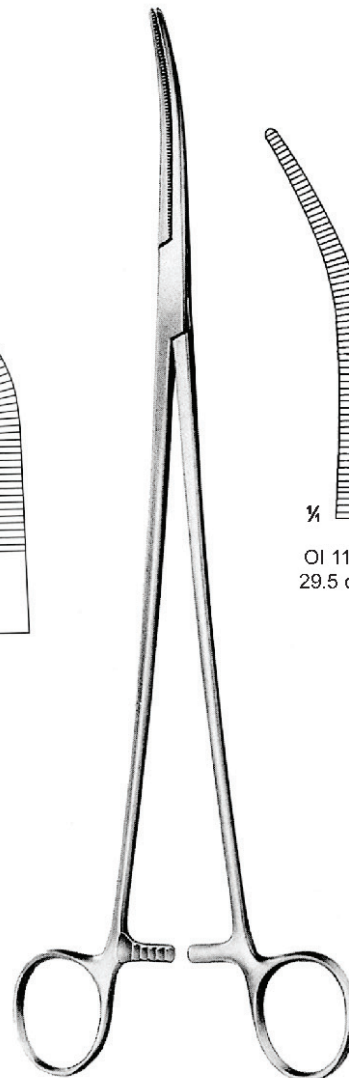

ZENKER



1/4
 OI 11-2653-29
 29.5 cm/11 5/8"

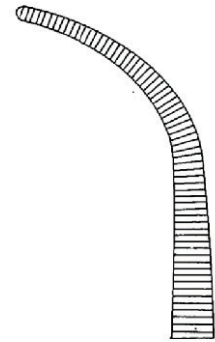

OI 11-2653-28
 28.5 cm/11 1/4"



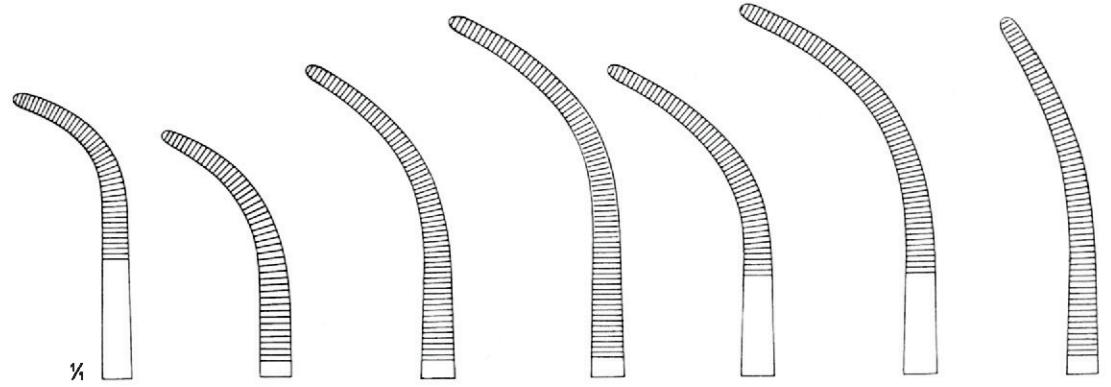

Fig. 1 OI 11-2654-20 20.5 cm/8 1/8"
 Fig. 2 OI 11-2655-20 20 cm/7 7/8"
 Fig. 3 OI 11-2655-21 21.5 cm/8 1/2"
 Fig. 4 OI 11-2655-22 22 cm/8 1/2"
 Fig. 5 OI 11-2656-21 21.5 cm/8 1/2"
 Fig. 6 OI 11-2656-22 22 cm/8 1/2"
 Fig. 7 OI 11-2657-22 22 cm/8 1/2"

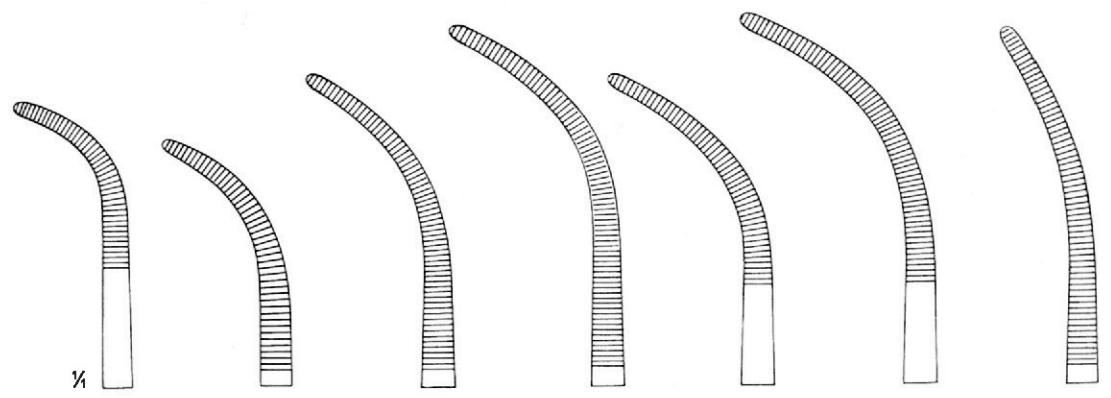

Fig. 1 OI 11-2658-27 27 cm/10 1/2"
 Fig. 2 OI 11-2658-26 26.5 cm/10 3/8"
 Fig. 3 OI 11-2659-27 27.5 cm/10 3/4"
 Fig. 4 OI 11-2659-28 28 cm/11"
 Fig. 5 OI 11-2660-27 27.5 cm/10 3/4"
 Fig. 6 OI 11-2660-28 28 cm/11"
 Fig. 7 OI 11-2661-28 27.5 cm/10 3/4"



OVERHOLT-GEISSENDORFER



OVERHOLT-FINO

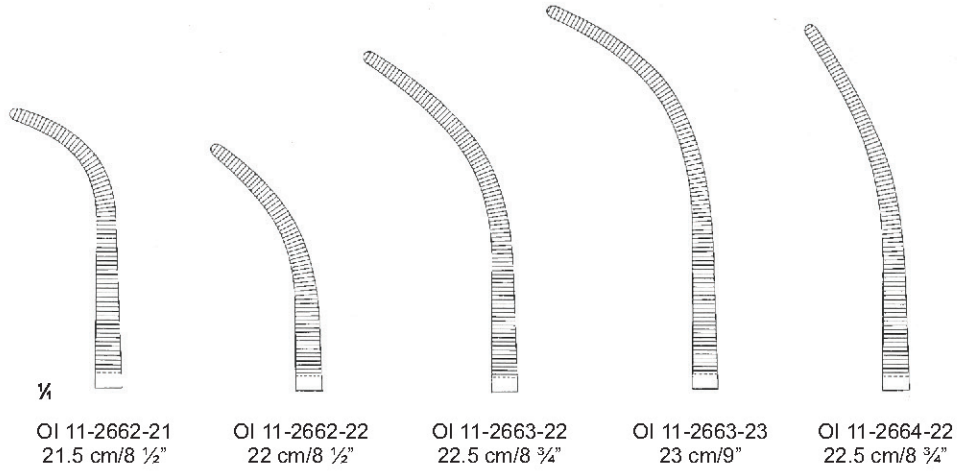

OVERHOLT-SLIM

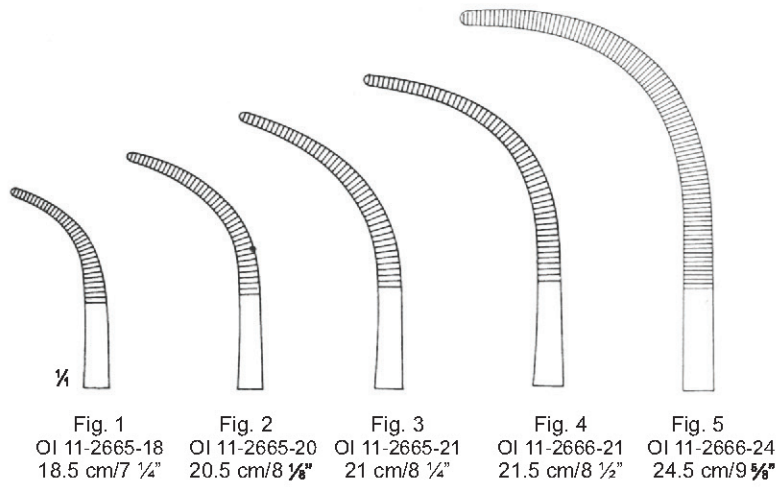



$\frac{1}{2}$
RUMEL
 23 cm/9"

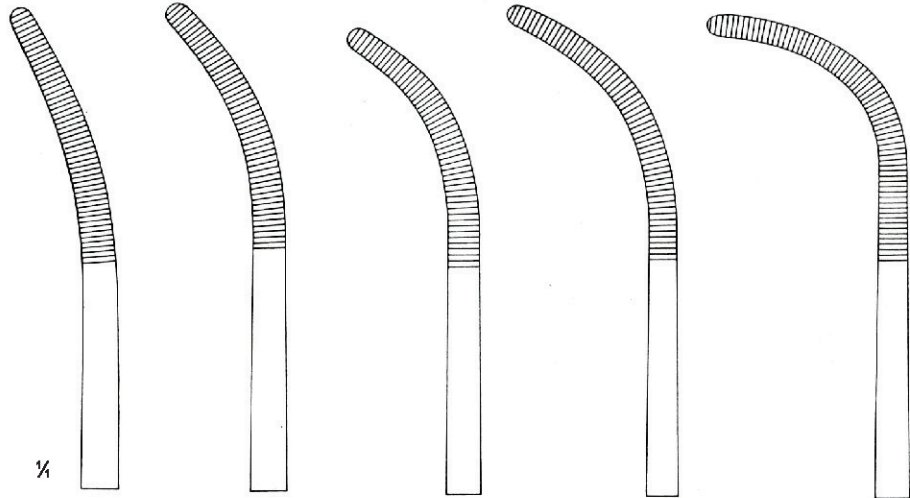

$\frac{1}{4}$
 OI 11-2667-23 OI 11-2668-23 OI 11-2669-23 OI 11-2670-23 OI 11-2671-23

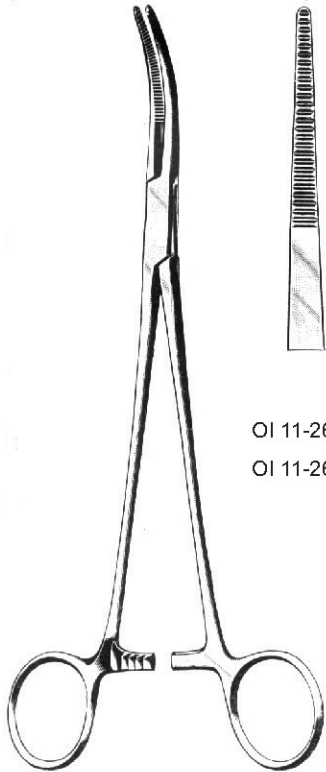

OI 11-2672-21
 OI 11-2672-26

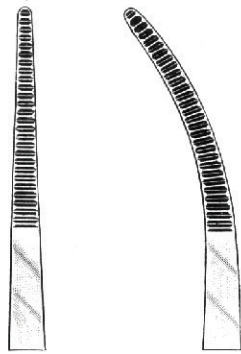

TOENNIS

OI 11-2673-21 21.0 cm 8 $\frac{1}{4}$ "
 OI 11-2673-26 26.0 cm 10 $\frac{1}{4}$ "

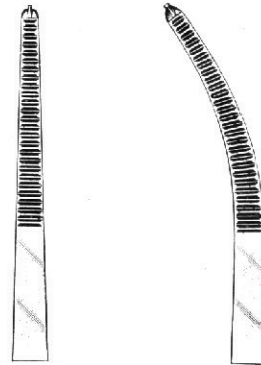

TOENNIS

1 : 2
 OI 11-2674-21 OI 11-2675-21
 OI 11-2674-26 OI 11-2675-26

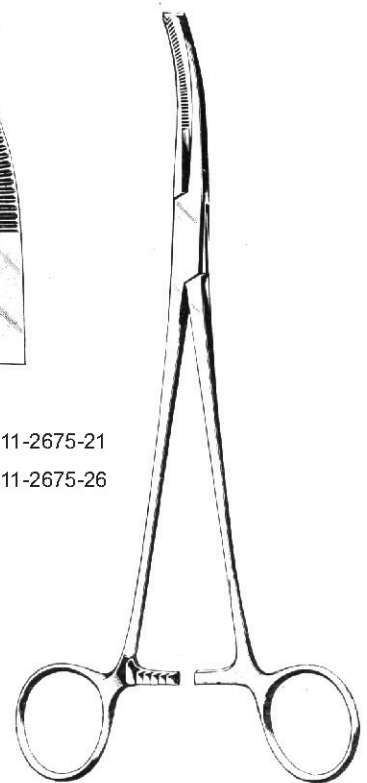

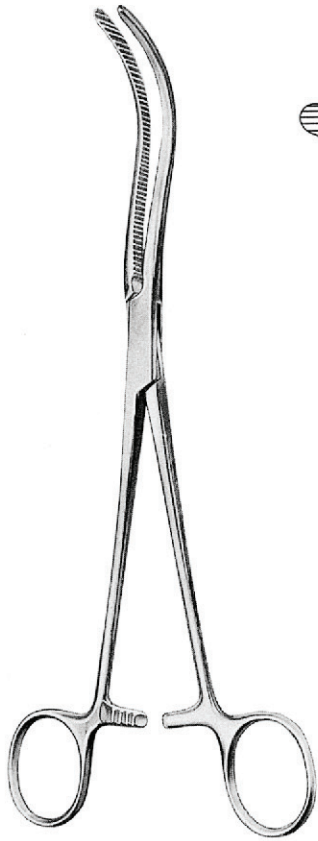

GUYON

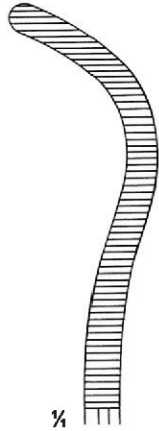

OI 11-2676-20
 20 cm/7 7/8"

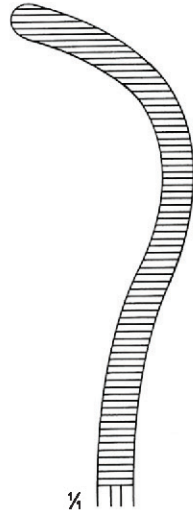

OI 11-2676-22
 22 cm/8 1/2"

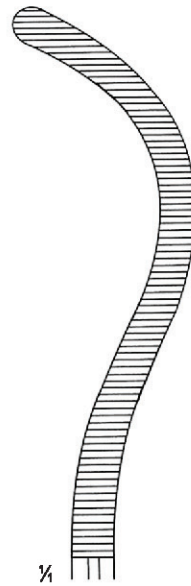

OI 11-2676-24
 24 cm/9 1/2"



GUYON
 OI 11-2677-23
 23 cm/9"

ATRAUMA



GUYON
 ATRAUMA

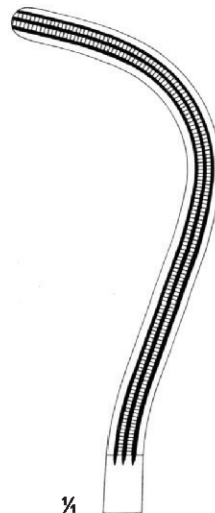

OI 11-2678-23
 23 cm/9"

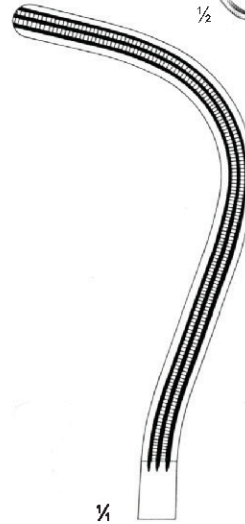

OI 11-2678-24
 24 cm/9 1/2"



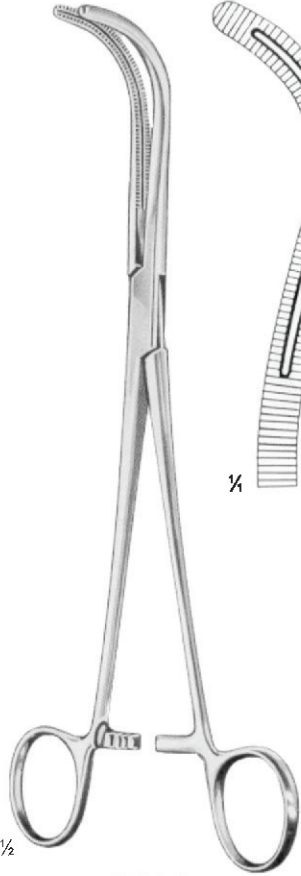

STILLE
OI 11-2679-23
23 cm/9"

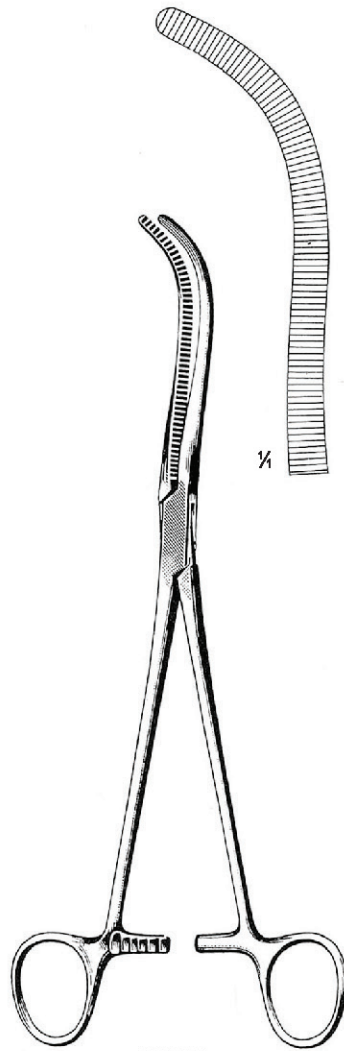

MAYO
OI 11-2680-23
23 cm/9"

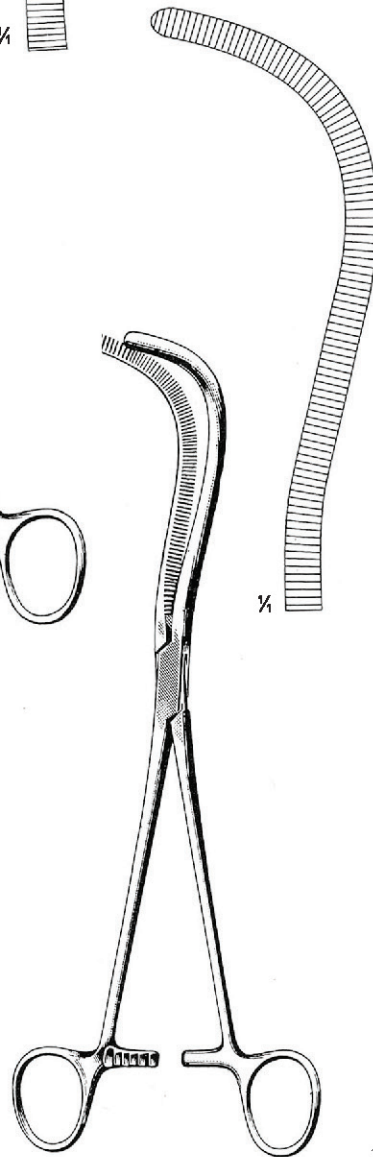

MAYO-GUYON
OI 11-2681-23
23 cm/9"

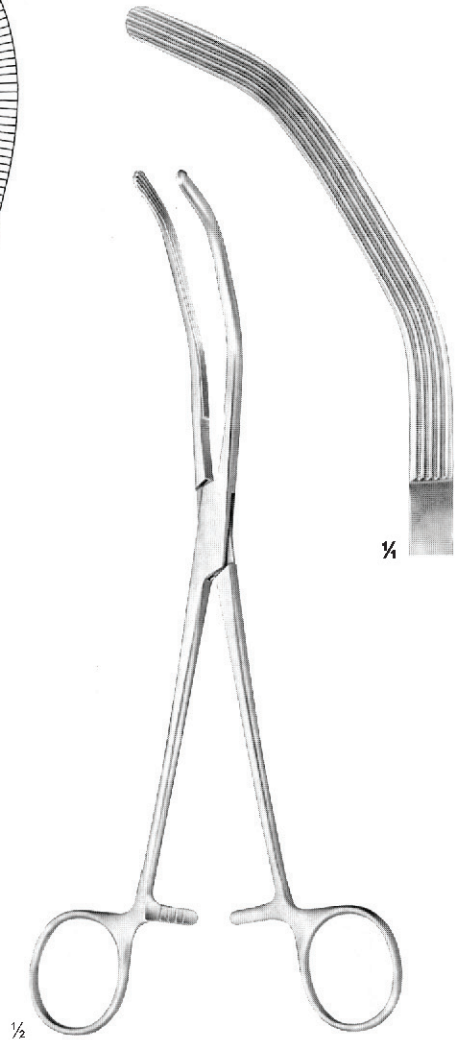

HERRICK
OI 11-2682-23
23 cm/9"

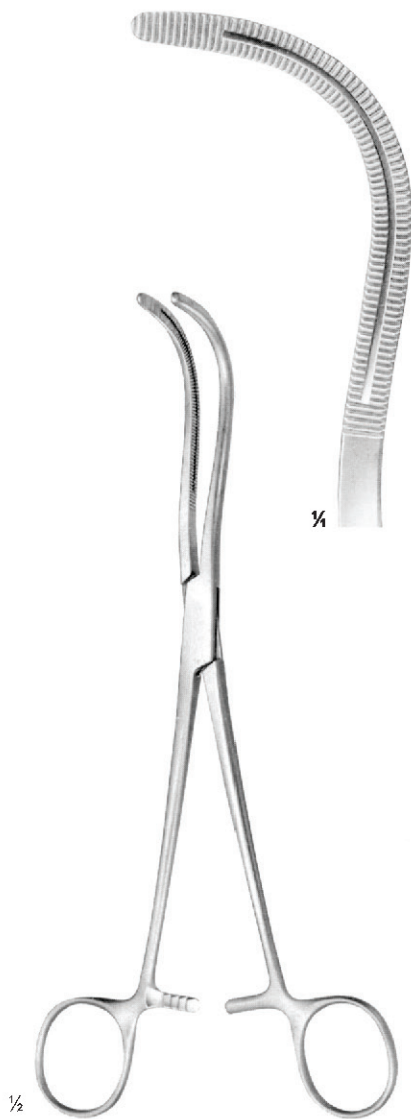

STILLE
 OI 11-2683-22
 22 cm/8 1/2"

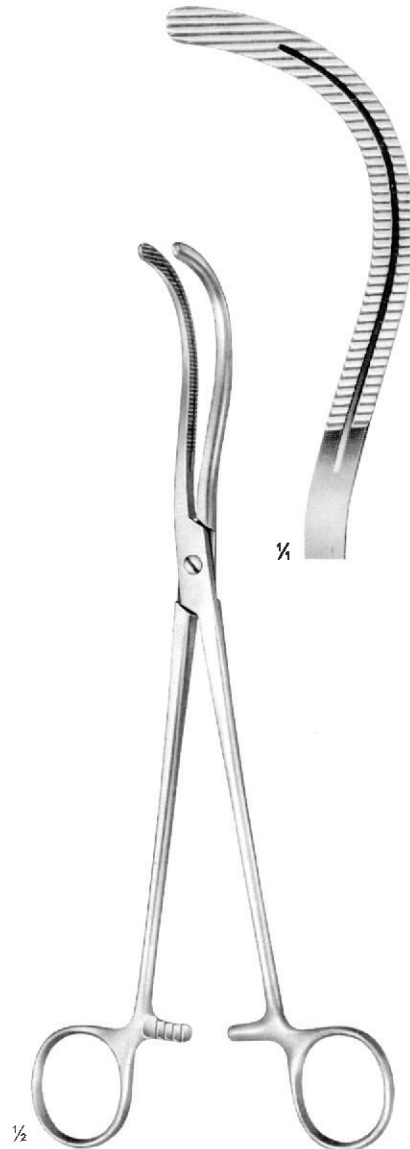

STILLE
 OI 11-2684-24
 24 cm/9 1/2"
 Screw Joint

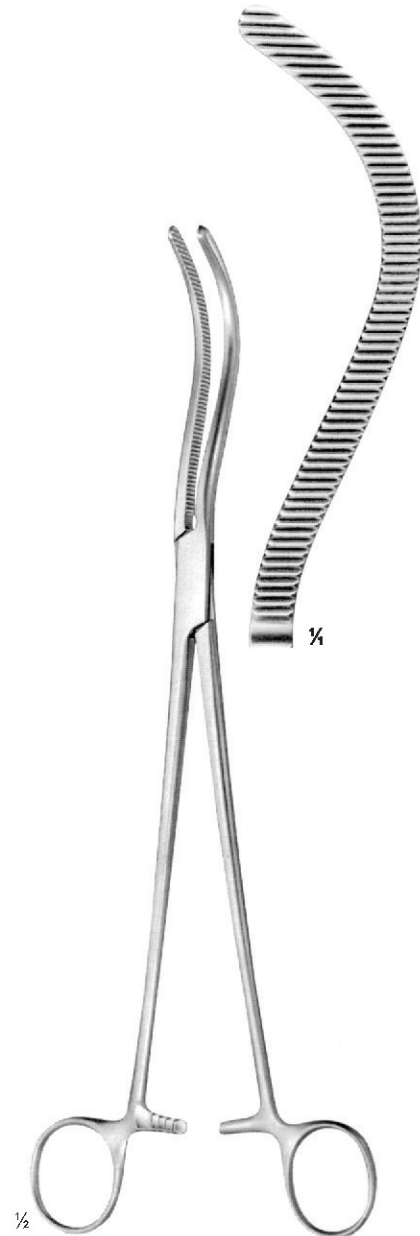

GUYON
 OI 11-2685-26
 26.5 cm/10 3/8"





GRAY

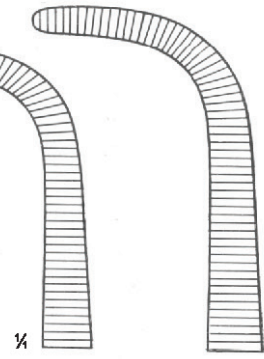

Fig. 1
 OI 11-2687-22
 22 cm/8 1/2"
 Fig. 2
 OI 11-2687-23
 23 cm/9"



GRAY
 1:2

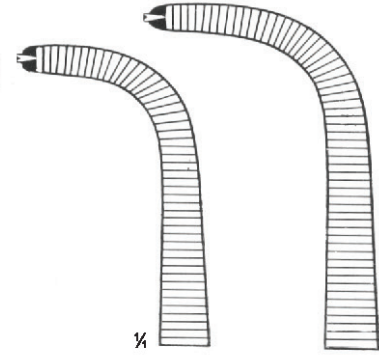
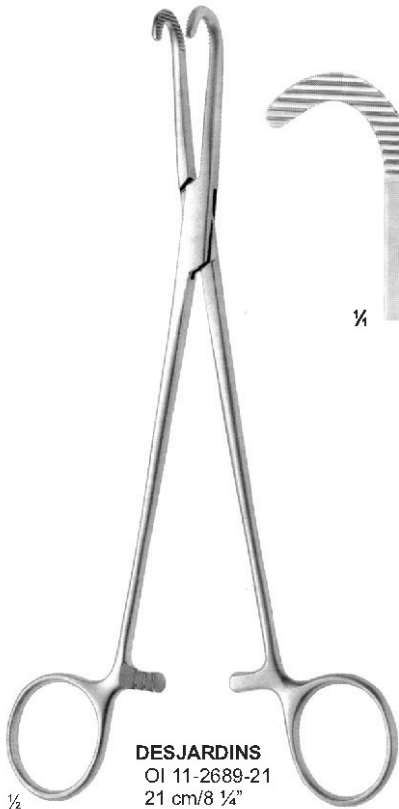

Fig. 1
 OI 11-2688-22
 22 cm/8 1/2"
 Fig. 2
 OI 11-2688-23
 23 cm/9"



DESJARDINS
 OI 11-2689-21
 21 cm/8 1/4"



1/4

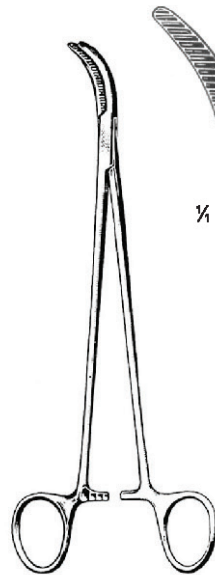

DESJARDINS
 OI 11-2690-21
 21 cm/8 1/4"



1/4



CRILE
 OI 11-2691-20
 20 cm/7 7/16"



1/4



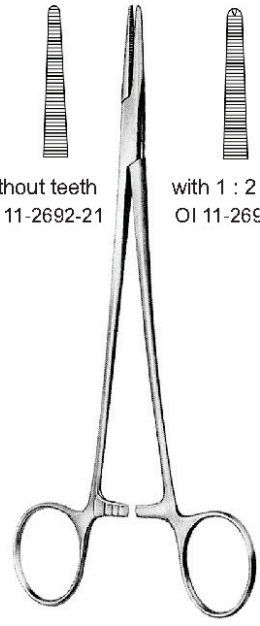
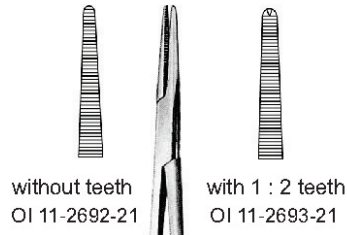

HOSEMANN
 21 cm/8 1/4"



1/2

NEGUS
 19 cm/7 1/2"



Fig. 1
 OI 11-2694-19



Fig. 2
 OI 11-2695-19



Fig. 1
 OI 11-2696-21

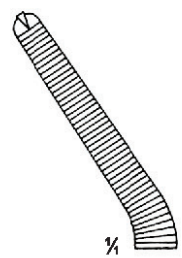
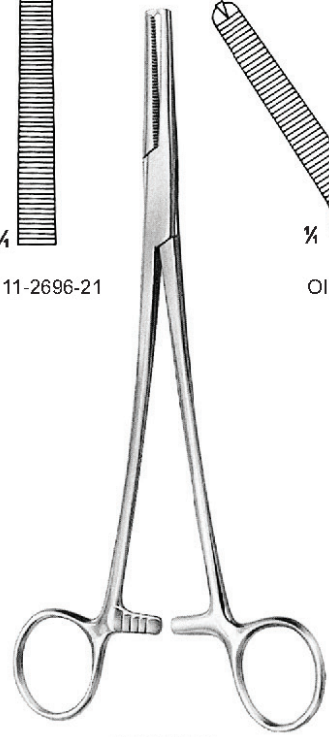
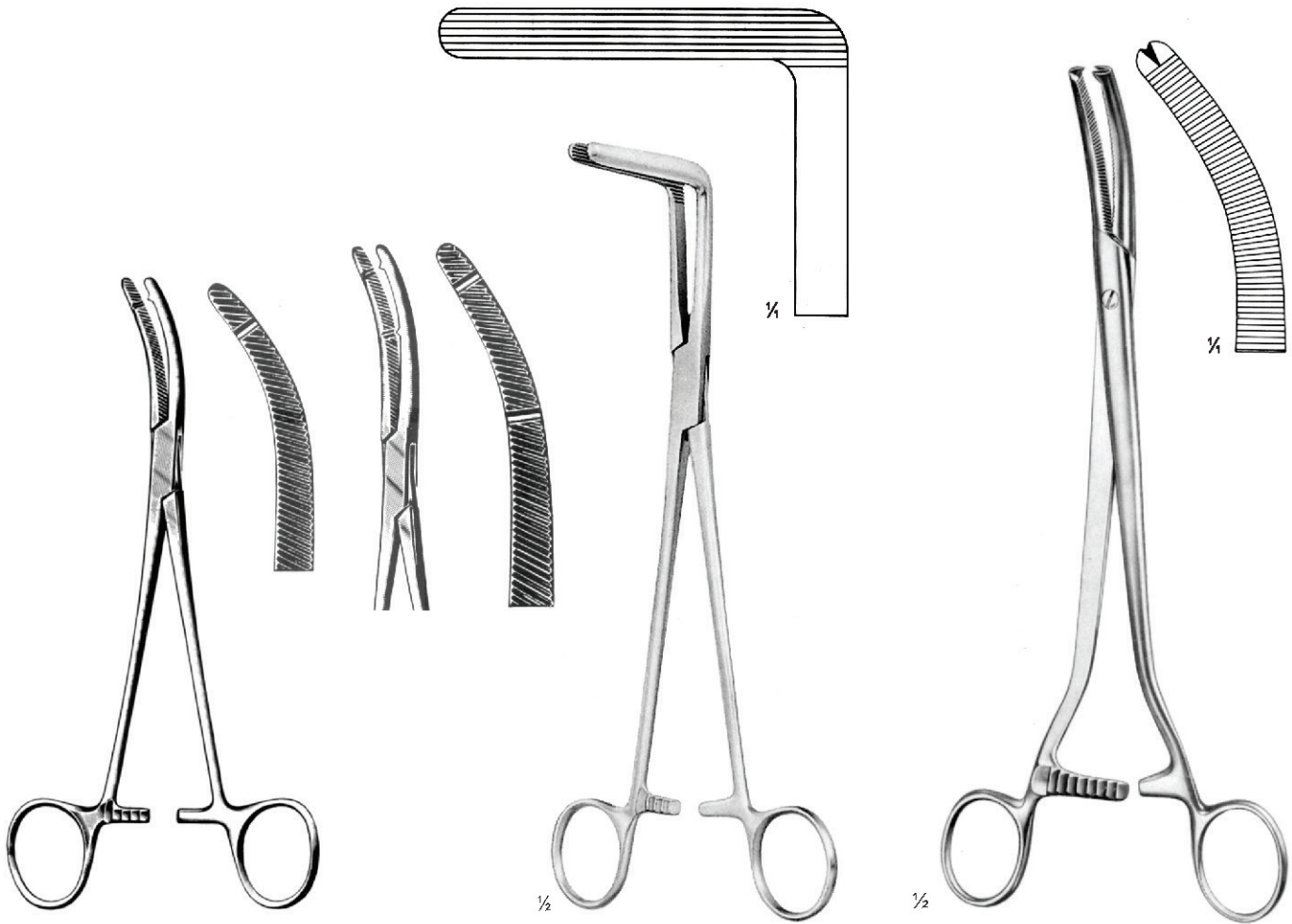

Fig. 2
 OI 11-2697-21



PHANEUF
 21.5 cm/8 1/2"
 1 : 2





1 Tooth	HEANEY	2 Teeth
OI 11-2698-19	19.5 cm/7 1/2"	OI 11-2699-19
OI 11-2698-21	21.0 cm/8 1/4"	OI 11-2699-21
OI 11-2698-23	23.0 cm/9"	OI 11-2699-23

WERTHEIM-CULLEN
 OI 11-2700-21
 21.5 cm/8 1/2"

WERTHEIM
 OI 11-2701-24
 24 cm/9 1/2"
 Extra Strong



ROGERS

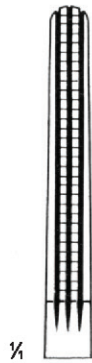

Fig. 1
 OI 11-2702-21
 21.5 cm/8 1/2"



Fig. 2
 OI 11-2703-21
 21 cm/8 1/4"



Fig. 3
 OI 11-2704-20
 20.5 cm/8 1/8"

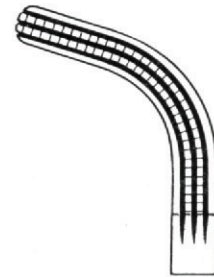

Fig. 4
 OI 11-2705-20
 20 cm/7 7/8"

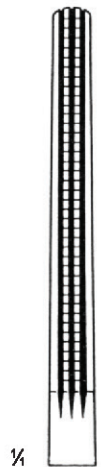

Fig. 1
 OI 11-2706-25
 25.5 cm/10"

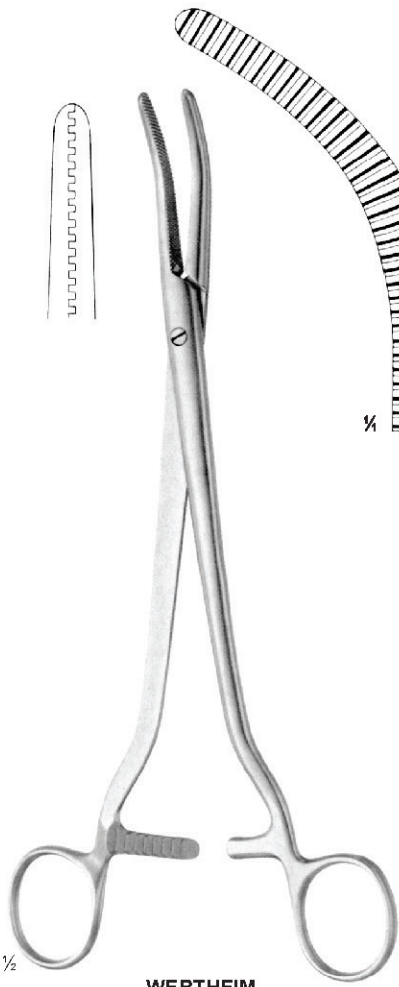

Fig. 2
 OI 11-2707-25
 25 cm/9 7/8"

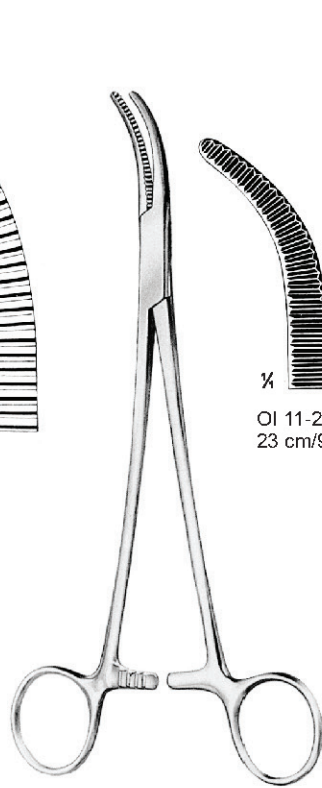

Fig. 3
 OI 11-2708-24
 24.5 cm/9 5/8"





WERTHEIM
OI 11-2709-25
25 cm/9 7/8"



MOYNIHAN

1/4
OI 11-2710-23
23 cm/9"

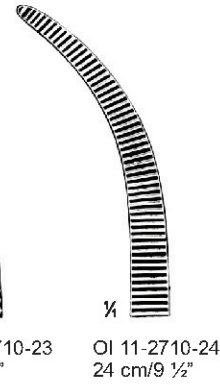

1/2
Heaney-Ballentine
21 cm/8 1/4"

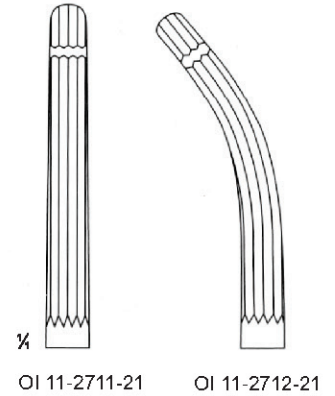

1/4
OI 11-2711-21

OI 11-2712-21

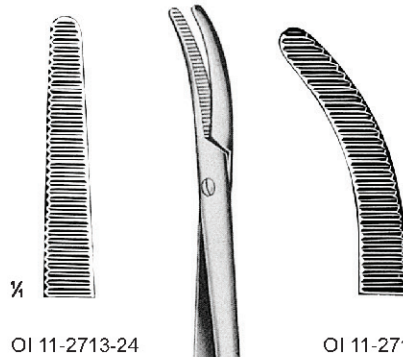

1/4
OI 11-2713-24



OI 11-2714-24

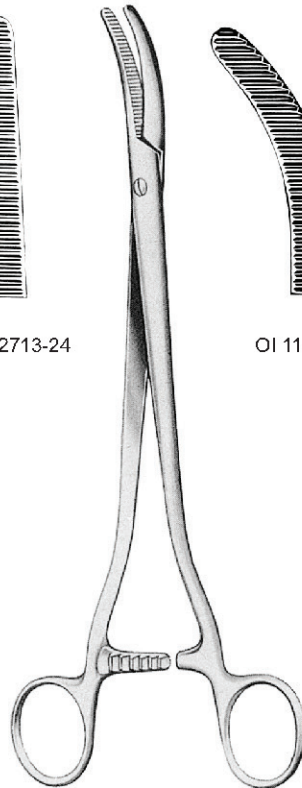

SEGOND-LANDAU
24 cm/9 1/2"

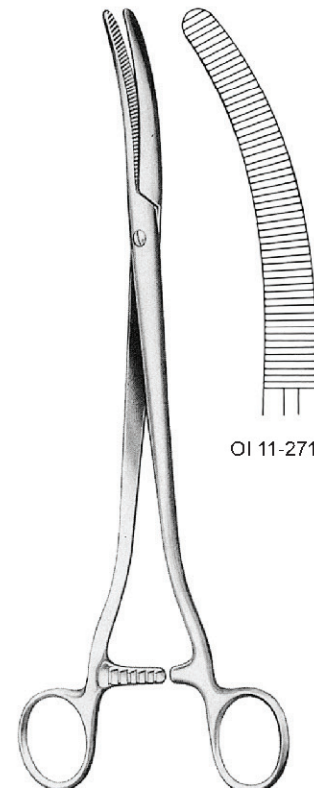

FAURE
25 cm/9 7/8"

OI 11-2715-25

ARTERY FORCEPS

Heavy pattern

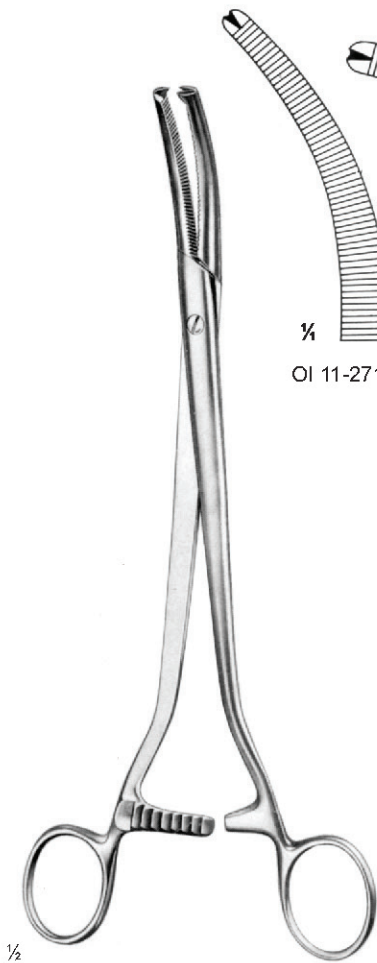

WERTHEIM
 23 cm/9"

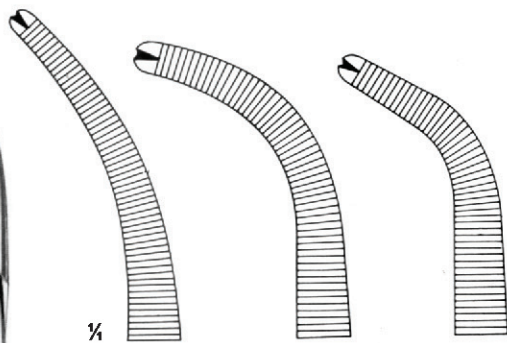

OI 11-2716-23 OI 11-2717-23 OI 11-2718-23

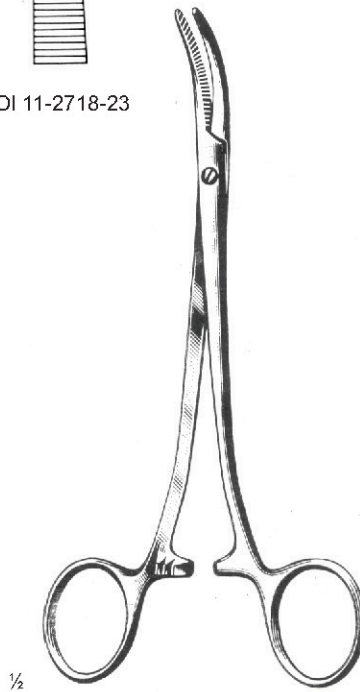

WERTHEIM
 OI 11-2719-18
 18 cm/7 1/8"

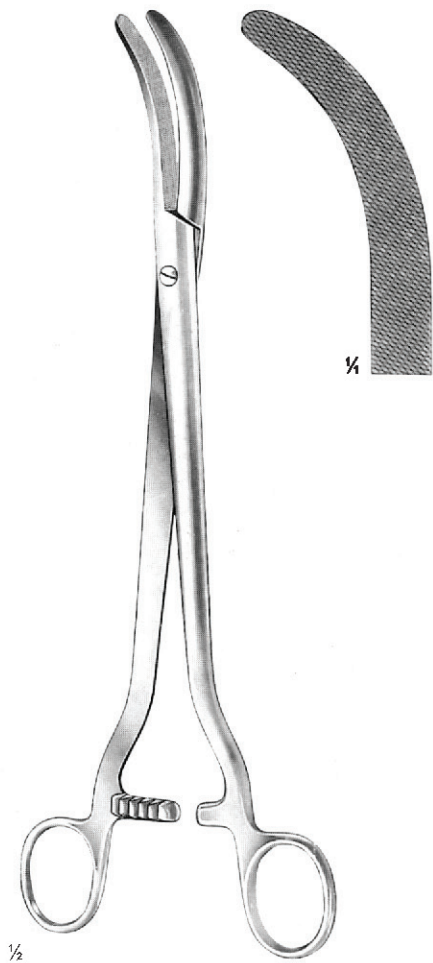

WERTHEIM
 OI 11-2720-25
 25 cm/9 1/8"



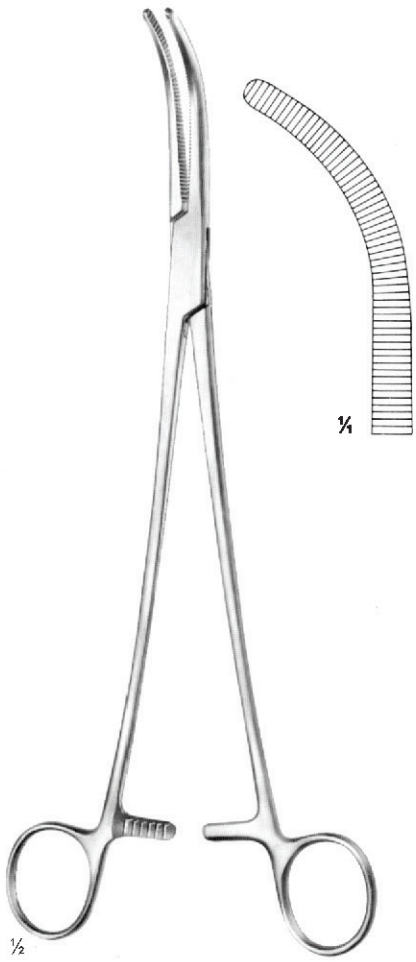

WERTHEIM
OI 11-2721-25
25 cm/9 7/8"

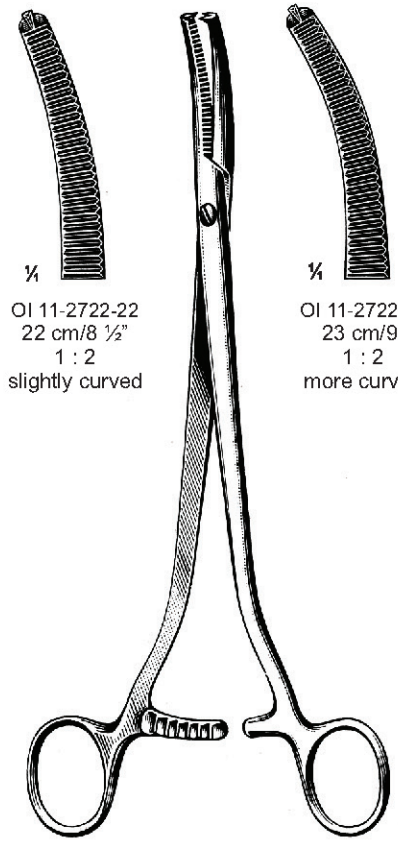

1/4
OI 11-2722-22
22 cm/8 1/2"
1 : 2
slightly curved

1/4
OI 11-2722-23
23 cm/9"
1 : 2
more curved

WERTHEIM

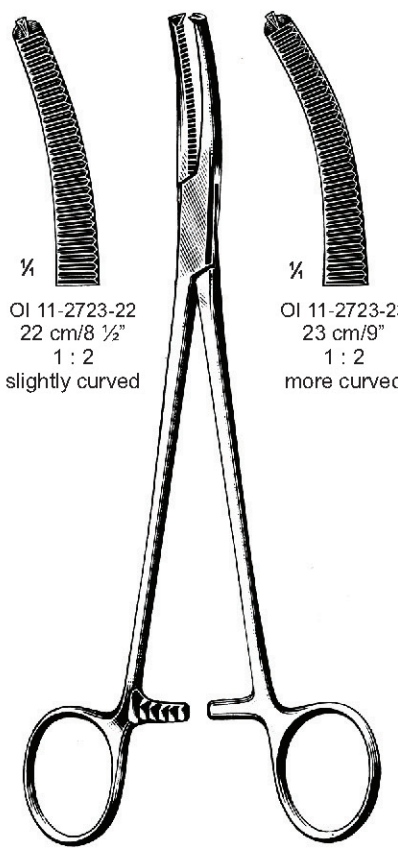

1/4
OI 11-2723-22
22 cm/8 1/2"
1 : 2
slightly curved

1/4
OI 11-2723-23
23 cm/9"
1 : 2
more curved

WERTHEIM

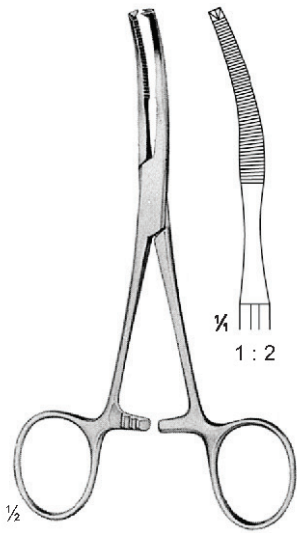

BABY-MIKULICZ
 OI 11-2724-14
 14 cm/5 1/2"

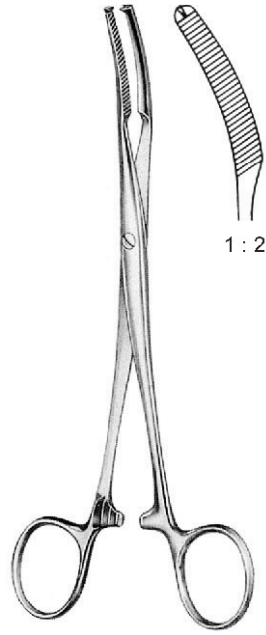

MIKULICZ
 OI 11-2725-18 18 cm/7 1/8"
 OI 11-2725-20 20 cm/7 7/8"

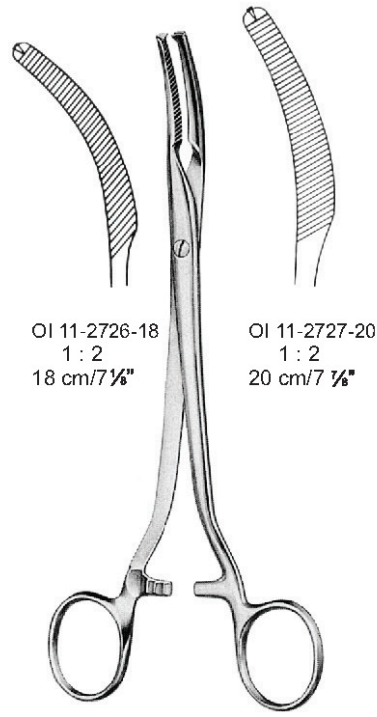

OI 11-2726-18
 1: 2
 18 cm/7 1/8"

OI 11-2727-20
 1: 2
 20 cm/7 7/8"

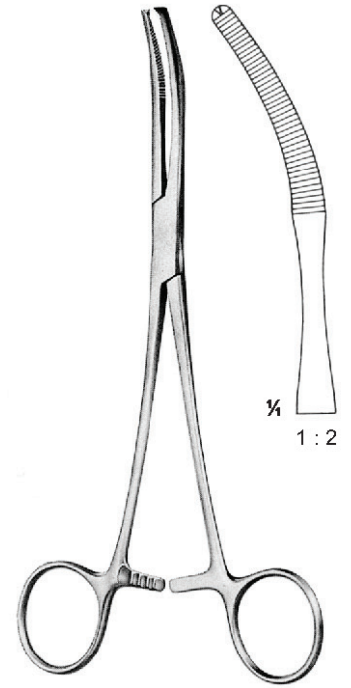

MIKULICZ
 OI 11-2728-20 20 cm/7 7/8"

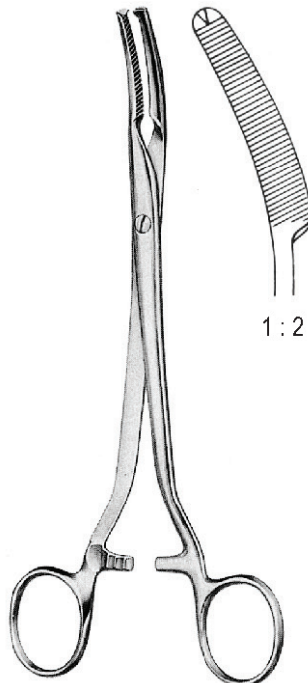

MIKULICZ
 OI 11-2729-20
 20.5 cm/8 1/8"

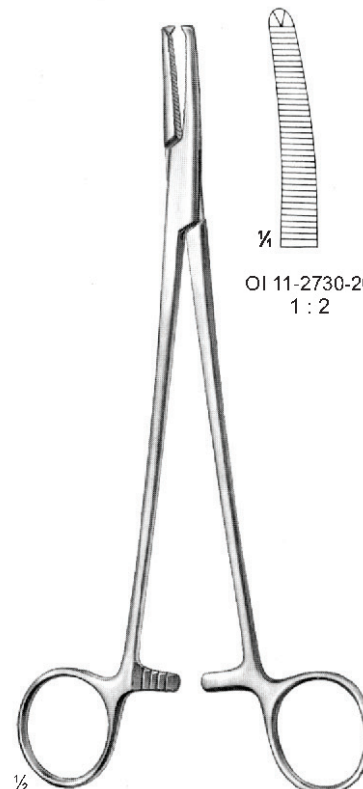

FAURE
 20 cm/7 7/8"



OI 11-2730-20
 1: 2



OI 11-2731-20
 1: 2



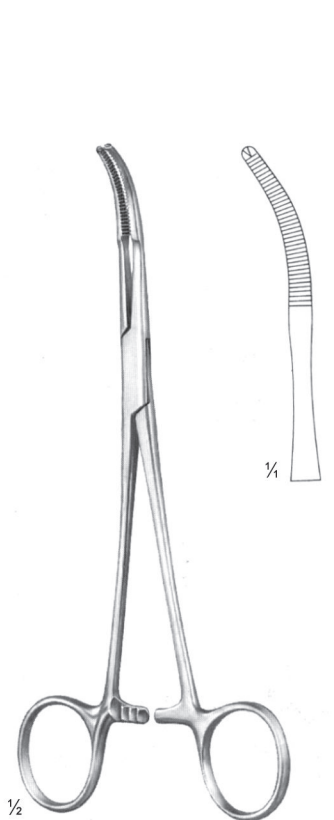

1/2
MIKULICZ
OI 11-2732-18
18 cm/7 1/8"

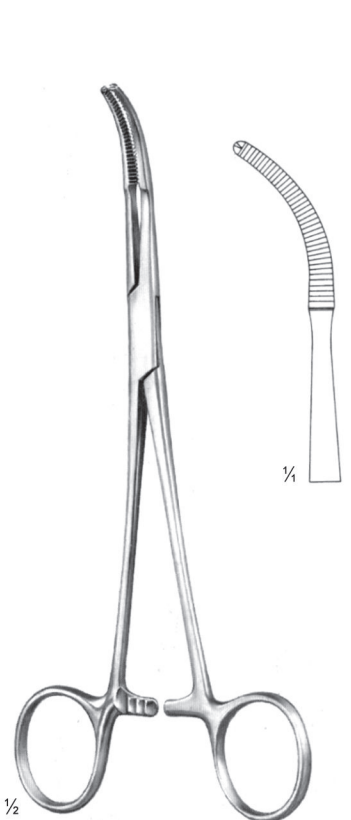

1/2
MIKULICZ
OI 11-2733-20
20 cm/7 7/8"

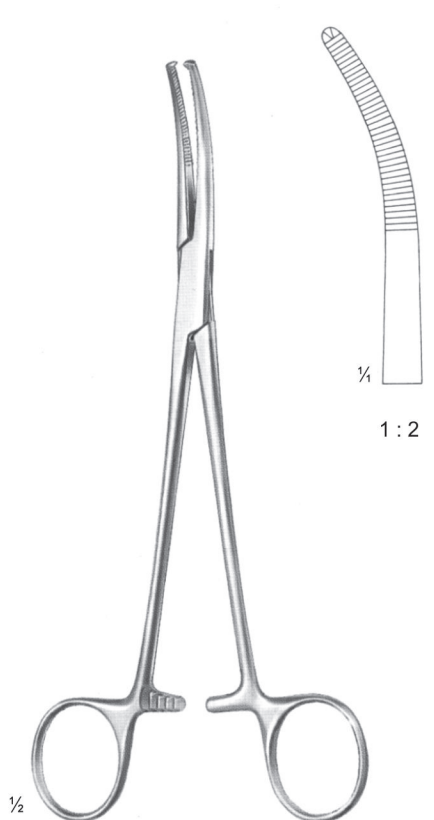

1/2
MIKULICZ
OI 11-2734-20
20.5 cm/8 1/8"

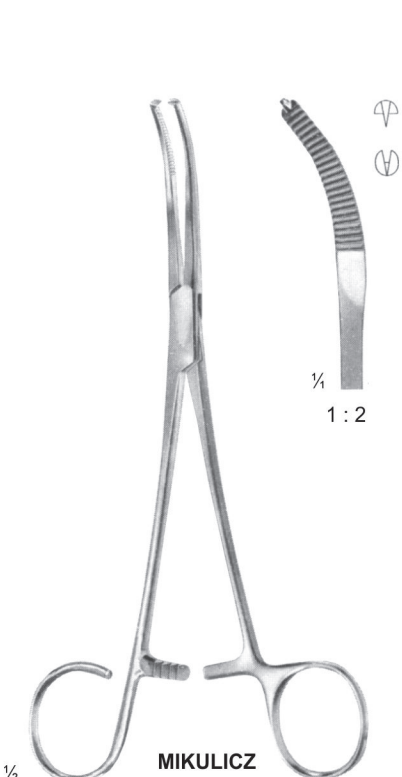

1/2
MIKULICZ
OI 11-2735-18
18.5 cm/7 1/4"

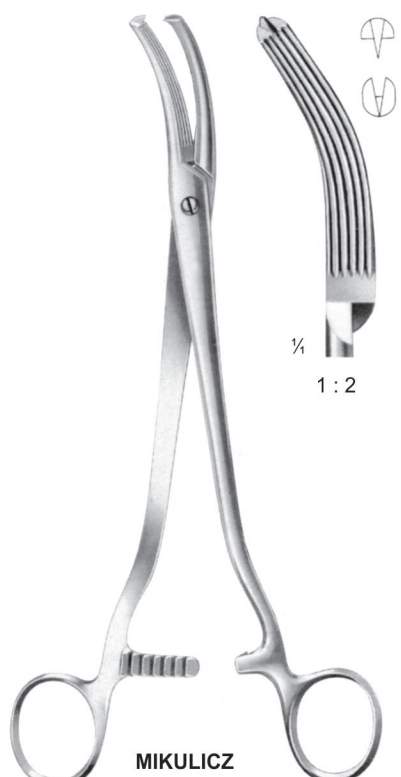

1/2
MIKULICZ
OI 11-2736-24
24.5 cm/9 5/8"

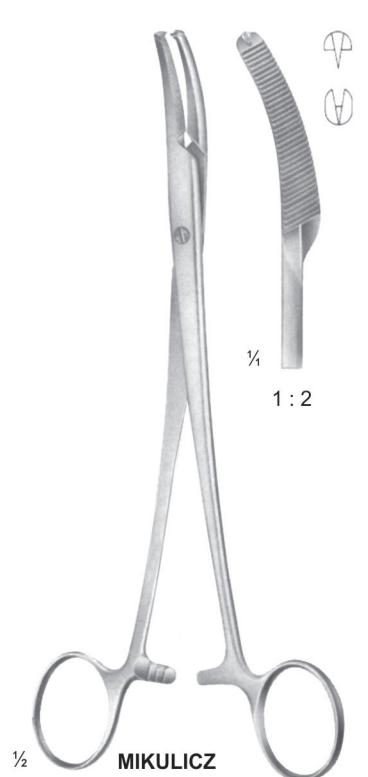

1/2
MIKULICZ
OI 11-2737-20
20 cm/7 7/8"

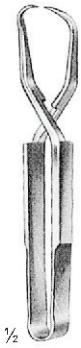

SCHAEDEL
 OI 11-2738-09
 9 cm/3 1/2"

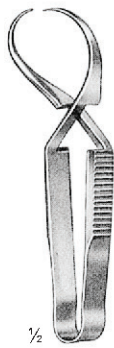

ENGL. MODELL
 OI 11-2739-09
 9 cm/3 1/2"



JONES
 OI 11-2740-05 5 cm/2"
 OI 11-2740-09 9 cm/3 1/2"



JONES
 OI 11-2741-09
 9 cm/3 1/2"



DOYEN
 OI 11-2742-11
 11 cm/4 3/8"

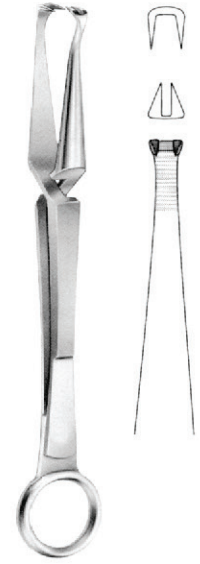

DOYEN
 OI 11-2743-18
 18 cm/7 1/8"

With Clip for Tubing or Cable



BACKHAUS
 OI 11-2744-11 11 cm/4 3/8"
 OI 11-2744-13 13 cm/5 1/8"
 Delicate pattern, sharp



BACKHAUS
 OI 11-2745-11
 11 cm/4 3/8"
 With Clip for Tubing or Cable

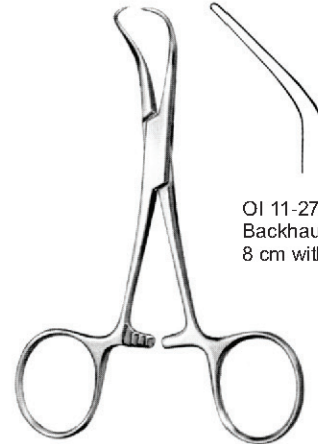

BACKHAUS
 OI 11-2747-08 Backhaus Towel
 8 cm with open jaws
 OI 11-2746-08 8 cm/3 1/8"
 OI 11-2746-08 11 cm/4 3/8"
 OI 11-2746-08 13 cm/5 1/8"
 OI 11-2746-08 15 cm/5 7/8"





BALL & SOCKET

OI 11-2748-11 11.5 cm/4 1/2"
OI 11-2748-14 14 cm/5 1/2"

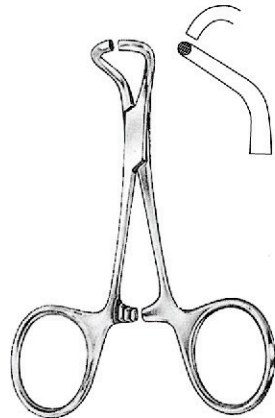

TOHOKU

OI 11-2749-10 10.5 cm/4 1/8"
OI 11-2749-13 13.5 cm/5 3/8"



PEERS BERTRAM

OI 11-2750-14 14.5 cm/5 3/4"

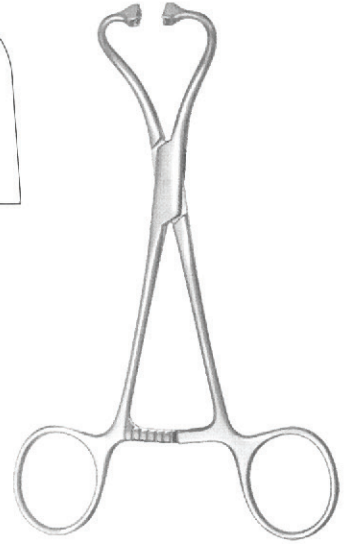
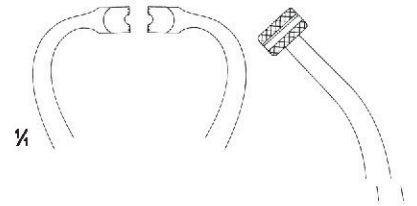

PEERS-BERTRAM MODIF.

OI 11-2751-15 15.5 cm/6 1/8"

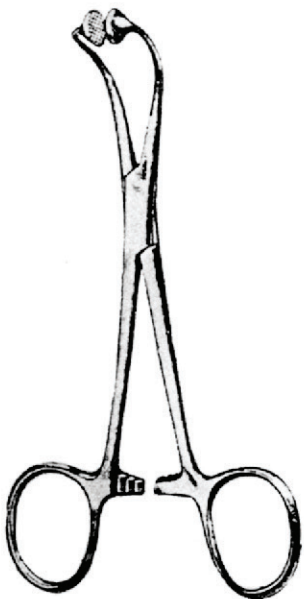

HOFF

OI 11-2752-11 11 cm/4 3/8"
OI 11-2752-14 14.5 cm/5 3/4"



ROBIN

OI 11-2753-13 13.5 cm/5 3/8"
with holder for cable up to 5 mm

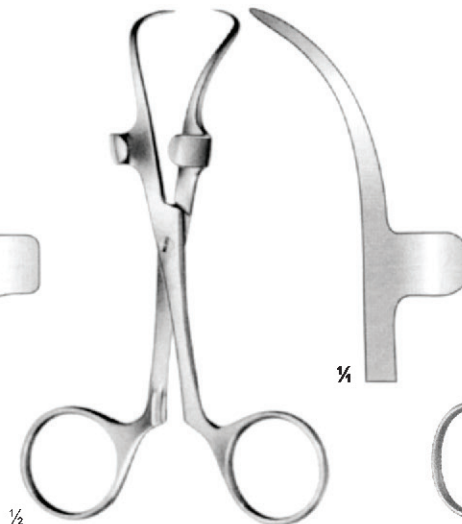

ROBIN

OI 11-2754-13 13.5 cm/5 3/8"
with holder for cable up to 13 mm tubing



PAPER TOWEL FORCEPS

OI 11-2755-10 10 cm/3 7/8"
OI 11-2755-13 13 cm/5 1/8"



ROEDER
 OI 11-2756-13 13 cm/5 1/8"
 OI 11-2756-15 15 cm/5 7/8"



LORNA
 OI 11-2757-10 10 cm/3 7/8"
 OI 11-2757-13 13 cm/5 1/8"



BERNHARD
 OI 11-2758-16
 16.5 cm/6 1/2"



LANE
 OI 11-2759-20
 20 cm/7 7/8"

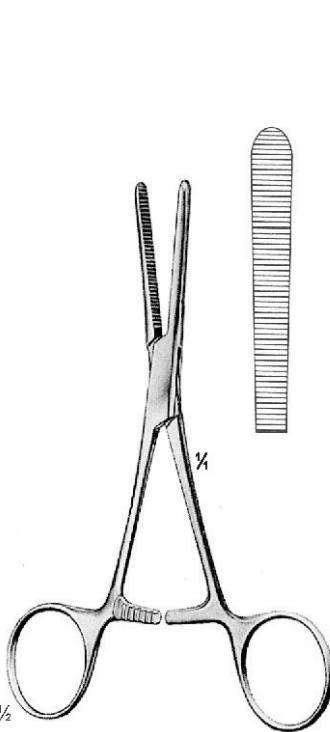
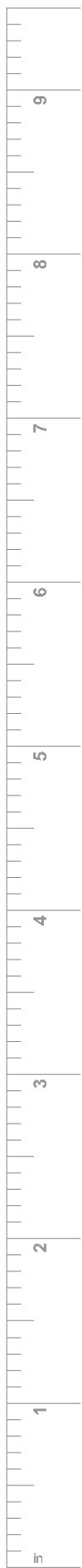
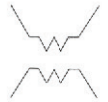

OI 11-2760-14
 14.5 cm/5 3/4"
 with extra long ratchet

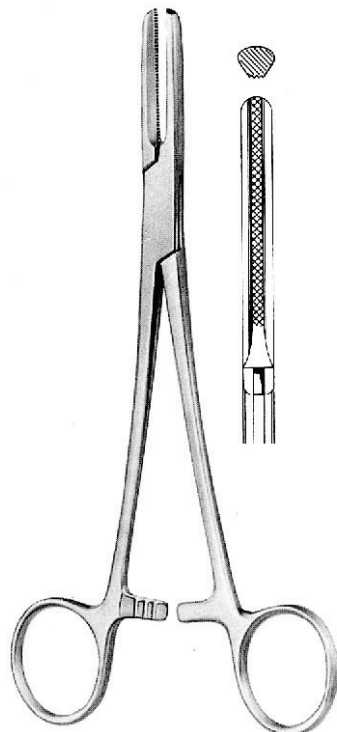

SCHOENBERG
 OI 11-2761-15 15.5 cm/6 1/8"
 OI 11-2761-19 19 cm/7 1/2"
 OI 11-2761-20 20 cm/7 7/8"



SCHOENBERG
 OI 11-2762-15 15.5 cm/6 1/8"
 OI 11-2762-19 19 cm/7 1/2"
 OI 11-2762-20 20 cm/7 7/8"
 with safety guard

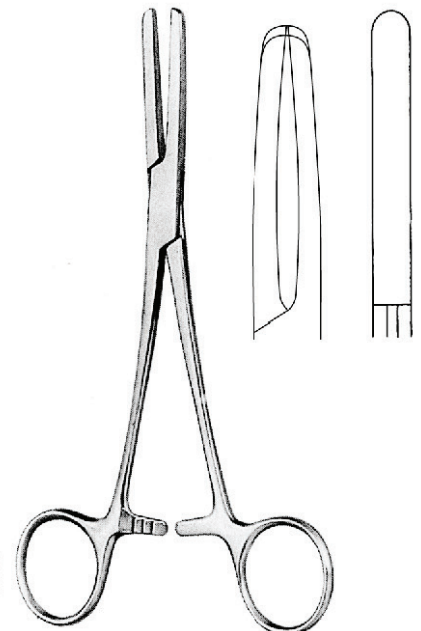

PRESBYTERIAN-HOSPITAL
 OI 11-2763-15 15.5 cm/6 1/8"
 OI 11-2763-19 19 cm/7 1/2"
 OI 11-2763-20 20 cm/7 7/8"

**LISTER**

OI 11-2764-20
 20 cm/7 7/8"

1/4

OI 11-2764-13
 13 cm/5 1/8"



OI 11-2764-15
 15 cm/5 7/8"

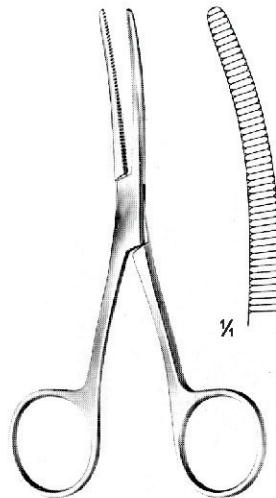

OI 11-2764-18
 18 cm/7 1/8"

**BRYANT**

OI 11-2765-13
 13 cm/5 1/8"

1/4