











- EN** Probes, Applicators, Spatulas
- DE** Sonden, Watteträger, Spatel
- ES** Sondas, Porta-algodones, Espátulas

Page 164 to 169





					
	1mm	2mm			
11.5cm	OI 13-2901-11	OI 13-2902-11	OI 13-2903-11		
12.5cm	OI 13-2901-12	OI 13-2902-12	OI 13-2903-12	OI 13-2904-12	OI 13-2905-12
14.0cm	OI 13-2901-14	OI 13-2902-14	OI 13-2903-14	OI 13-2904-14	OI 13-2905-14
16.0cm	OI 13-2901-16	OI 13-2902-16	OI 13-2903-16	OI 13-2904-16	OI 13-2905-16
18.0cm	OI 13-2901-18	OI 13-2902-18	OI 13-2903-18	OI 13-2904-18	OI 13-2905-18
20.0cm	OI 13-2901-20	OI 13-2902-20	OI 13-2903-20	OI 13-2904-20	OI 13-2905-20
25.0cm	OI 13-2901-25	OI 13-2902-25	OI 13-2903-25		

					
		<b>Silver</b>		<b>FISH</b>	<b>FISH</b>
10.5cm	OI 13-2906-10	11.5cm OI 13-2907-11	OI 13-2908-11	OI 13-2909-14	14.5cm OI 13-2910-10
13.0cm	OI 13-2906-13	12.5cm OI 13-2907-12	OI 13-2908-12	OI 13-2909-18	18.0cm
14.5cm	OI 13-2906-14	14.0cm OI 13-2907-14	OI 13-2908-14		
16.0cm	OI 13-2906-16	16.0cm OI 13-2907-16	OI 13-2908-16		
18.0cm	OI 13-2906-18	18.0cm OI 13-2907-18	OI 13-2908-18		
20.0cm	OI 13-2906-20	20.0cm OI 13-2907-20	OI 13-2908-20		
		25.0cm OI 13-2907-25	OI 13-2908-25		

**PROBES, APPLICATORS**



11.5cm OI 13-2911-11  
 12.5cm OI 13-2911-12  
 14.0cm OI 13-2911-14  
 16.0cm OI 13-2911-16  
 18.0cm OI 13-2911-18  
 20.0cm OI 13-2911-20



OI 13-2912-11  
 OI 13-2912-12  
 OI 13-2912-14  
 OI 13-2912-16  
 OI 13-2912-18  
 OI 13-2912-20



**DOYEN**  
 OI 13-2913-14  
 14.0cm



**NELATON**  
 OI 13-2914-16  
 16.0cm



OI 13-2915-12  
 12.0cm



**KRONECKER**  
 OI 13-2916-16  
 13.0 cm



**JOHNS-HOPKINS**  
 OI 13-2917-15  
 15.0 cm



**ROSER**  
 OI 13-2918-12  
 12.5 cm

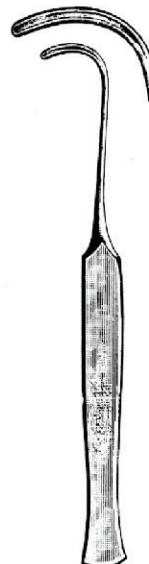

**SYME**  
 OI 13-2919-17  
 17.0 cm



OI 13-2920-17  
 17.0 cm





OI 13-2921-13 13.0 cm  
 OI 13-2921-14 14.5 cm



OI 13-2922-17  
 17.5 cm



**MCDONALD**  
 OI 13-2923-19  
 19.0 cm



**KILLIAN**  
 OI 13-2924-19  
 19.0 cm



**WATSON CHEYENE**  
 OI 13-2925-13 13.0 cm  
 OI 13-2925-19 19.0 cm



**WATSON CHEYENE**  
 OI 13-2926-17  
 17.5 cm



**PLAYFAIR**  
 OI 13-2927-31  
 31.0 cm



**CHEYENE**  
 OI 13-2928-12 12.5 cm  
 OI 13-2928-17 17.5 cm

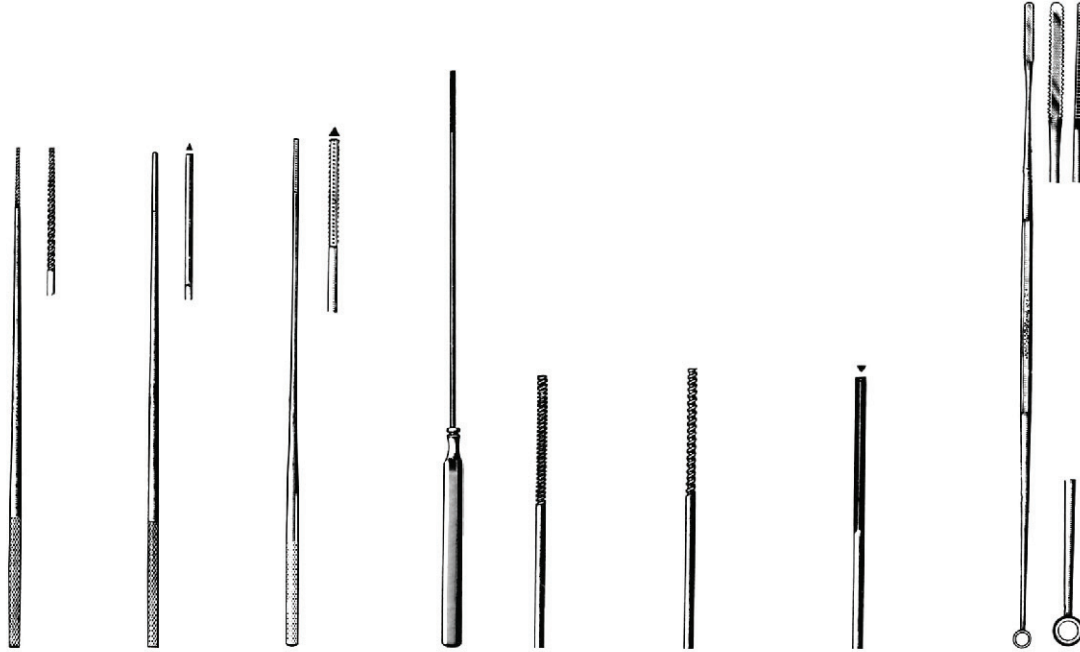

	<b>FARREL</b>	<b>FARREL</b>	<b>FARREL</b>
12.0cm	OI 13-2929-12	OI 13-2930-12	OI 13-2931-12
14.0cm	OI 13-2929-14	OI 13-2930-14	OI 13-2931-14
16.0cm	OI 13-2929-16	OI 13-2930-16	OI 13-2931-16
18.0cm	OI 13-2929-18	OI 13-2930-18	OI 13-2931-18
23.0cm	OI 13-2929-23	OI 13-2930-23	OI 13-2931-23

OI 13-2932-12  
 OI 13-2932-14  
 OI 13-2932-16  
 OI 13-2932-18

OI 13-2933-12  
 OI 13-2933-14  
 OI 13-2933-16  
 OI 13-2933-18

OI 13-2934-12  
 OI 13-2934-14  
 OI 13-2934-16  
 OI 13-2934-18

**JOBSON-HORNE**  
 OI 13-2935-12 12.5 cm  
 OI 13-2935-18 18.0 cm

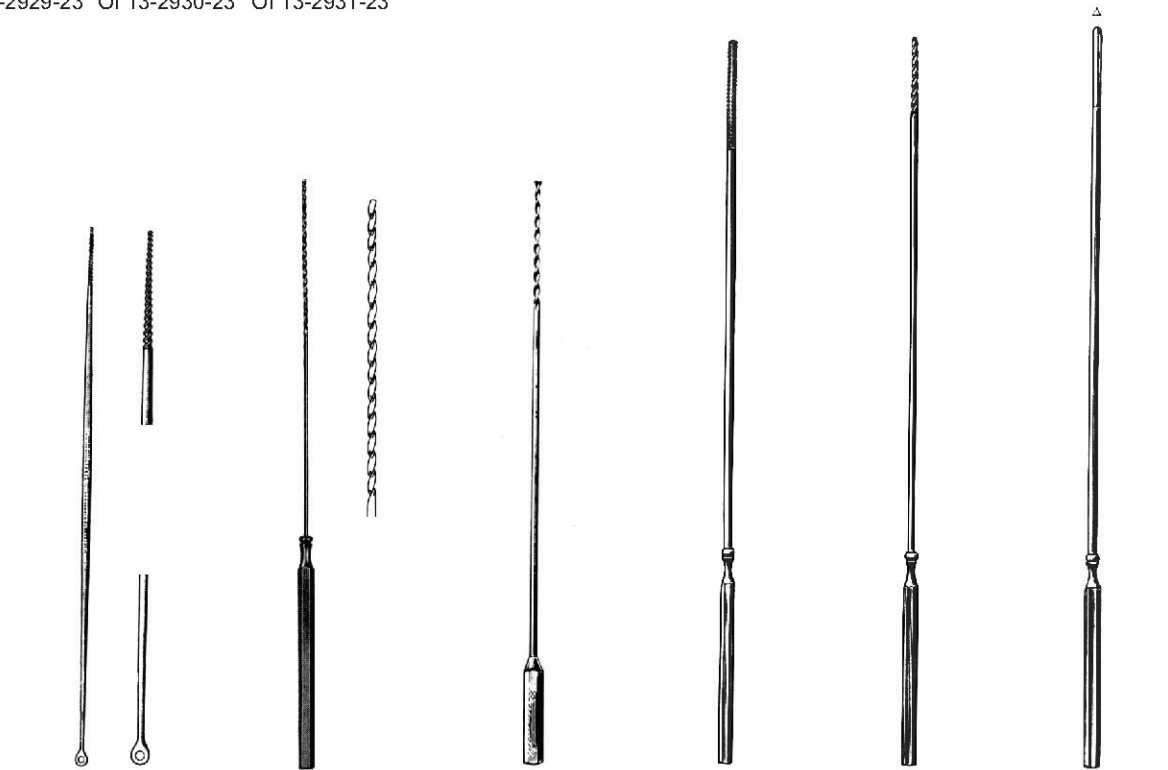

**JOBSON-HORNE**  
 OI 13-2936-15  
 15.0 cm

OI 13-2937-16  
 16.0 cm

OI 13-2938-25  
 25.0 cm

OI 13-2939-28  
 28.0 cm

OI 13-2940-28  
 28.0 cm

OI 13-2941-28  
 28.0 cm





**HARTMANN**  
 OI 13-2942-20  
 20.0 cm

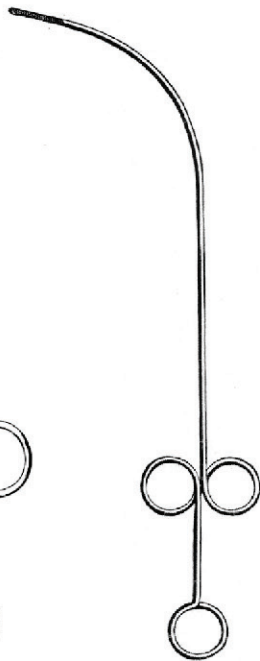

**FEIN**  
 OI 13-2943-28  
 28.0 cm



**TOBOLD**  
 OI 13-2944-25  
 25.0 cm

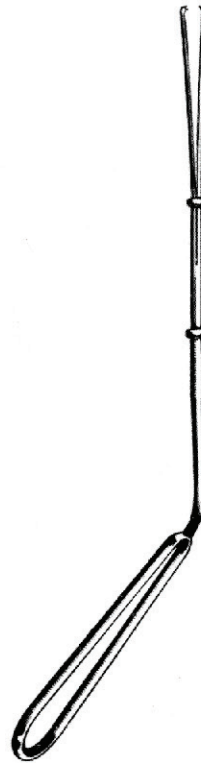

OI 13-2945-40  
 40.0 cm

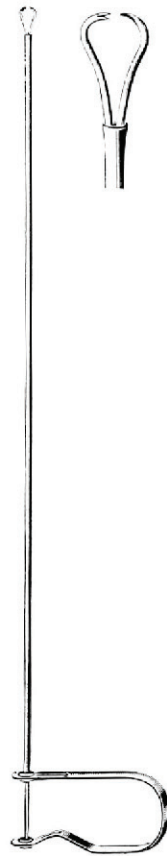

OI 13-2946-45  
 45.0 cm

**PROBES, APPLICATORS**

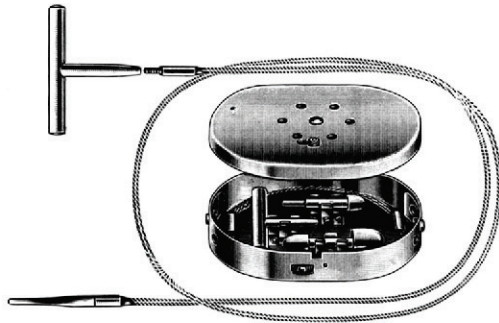

**NABATOFF**  
 OI 13-2947-00  
 complete set.  
 135 x 100 x 25mm

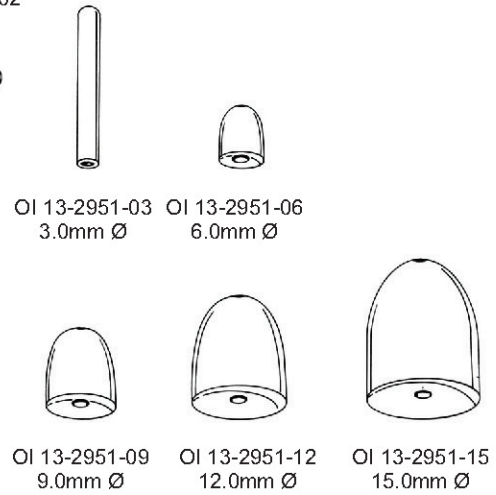
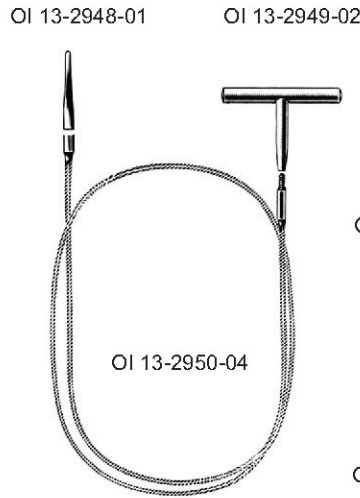

OI 13-2952-12  
 12.0 cm



50.0 cm

