

- EN** Oral Instruments
- DE** Mund instrumente
- ES** Cirugía oral

Page 575 to 594

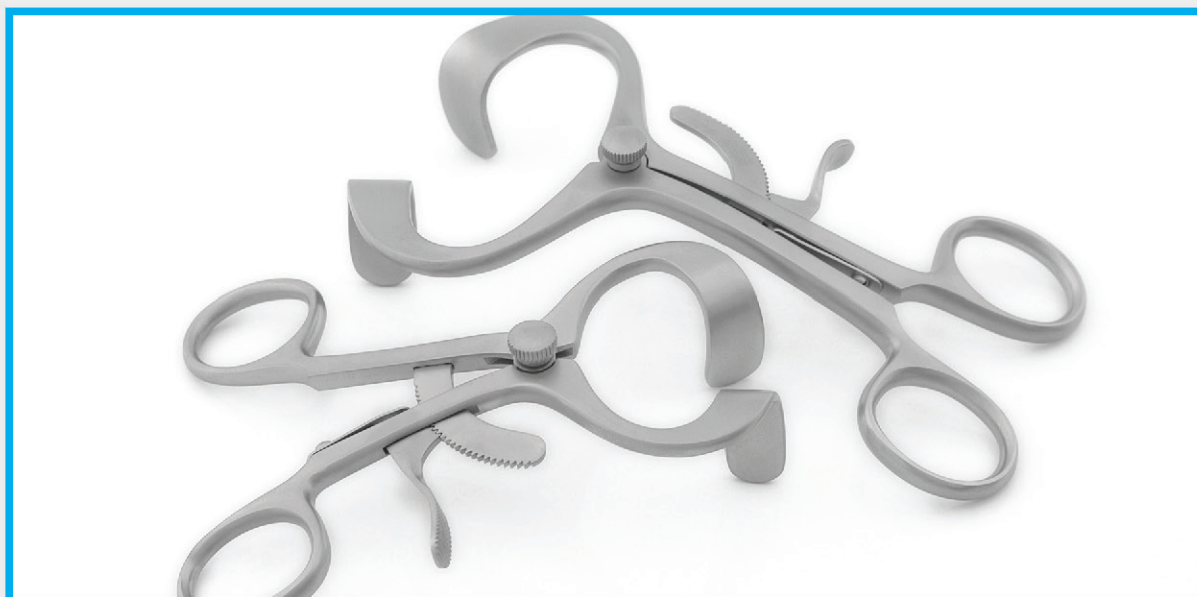

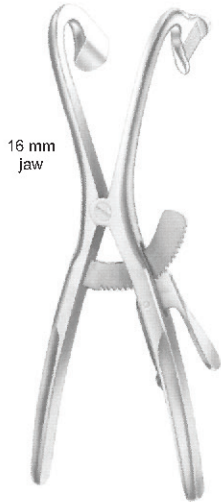

16 mm
jaw

DENHART
OI 23-6901-12
12 cm/4 3/4"

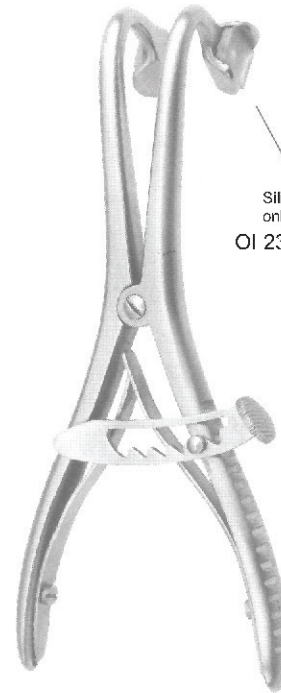

Silicon jaws
only (pair)
OI 23-6903-12

DENHART
OI 23-6902-12
12 cm/4 3/4"

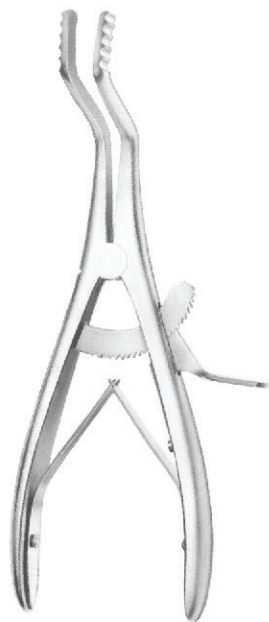

ROSER-KONIG

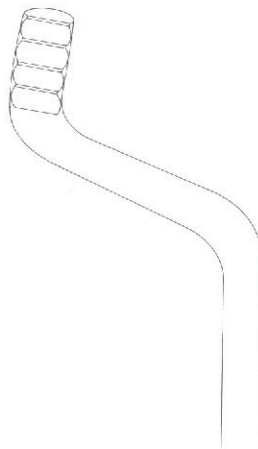

OI 23-6904-16
16 cm/6 1/4"

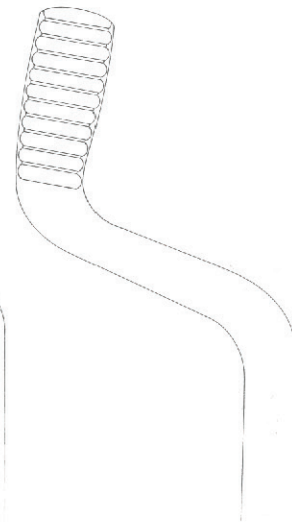

OI 23-6904-19
19 cm/7 1/2"

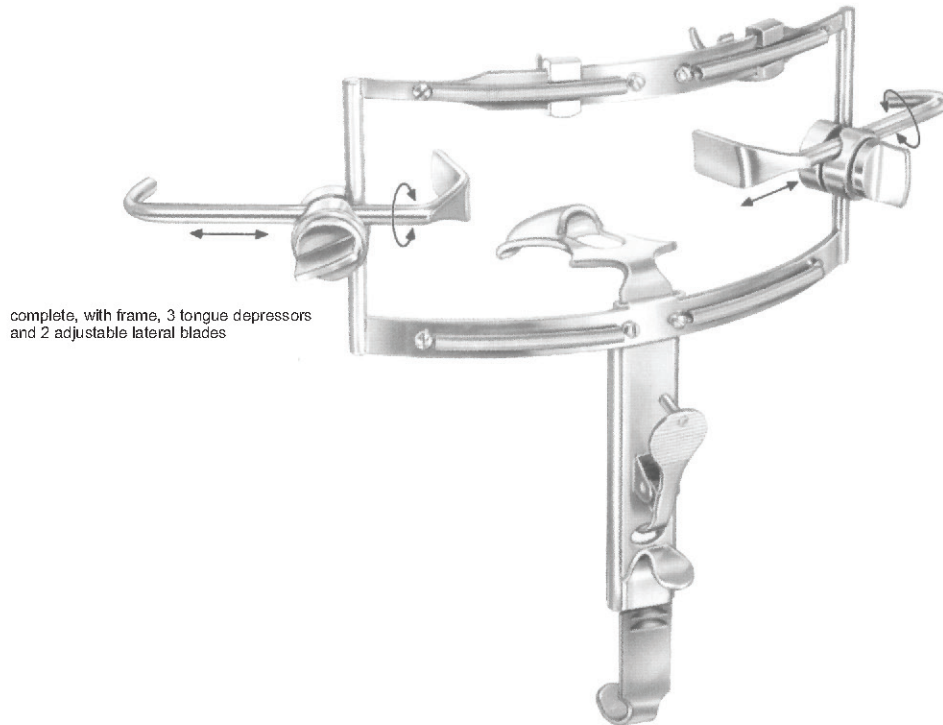

complete, with frame, 3 tongue depressors and 2 adjustable lateral blades

DINGMAN
 OI 23-6905-00
 Complete set
 Fig. 1 - 3

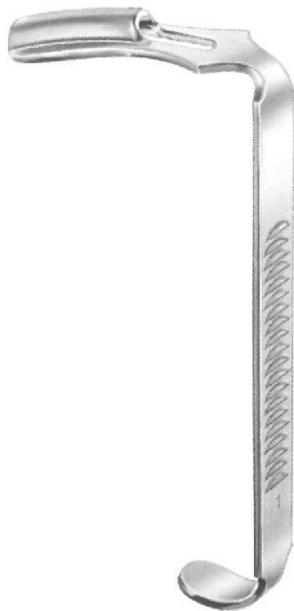

OI 23-6906-01
 62 mm x 26 mm

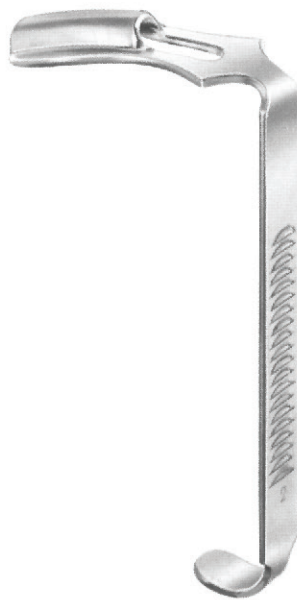

OI 23-6907-02
 65 mm x 30 mm



OI 23-6908-03
 78 mm x 32 mm

Tongue Depressors



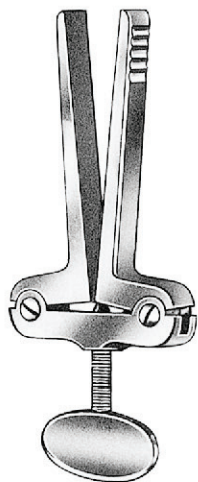

HEISTER
OI 23-6909-13
13 cm/5 1/8"



OI 23-6911-11
Spare rubber

MOLT
OI 23-6910-11
11 cm/4 3/8"

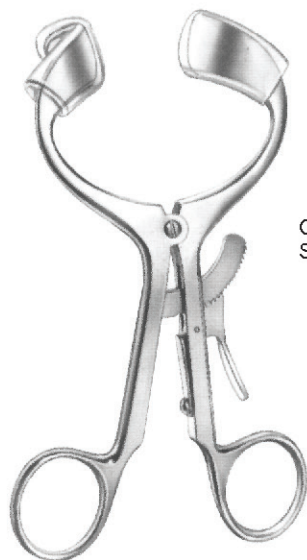

OI 23-6913-13
Spare Rubber

MOLT
OI 23-6912-13
13 cm/5 1/8"

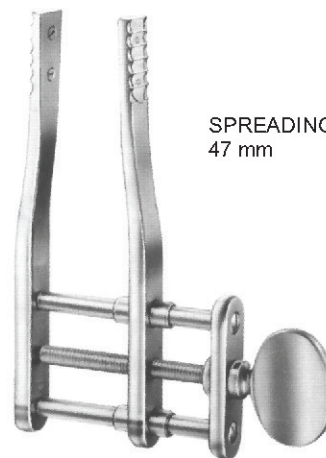

SPREADING
47 mm

OBWEGESER
OI 23-6914-11
11 cm/4 3/8"

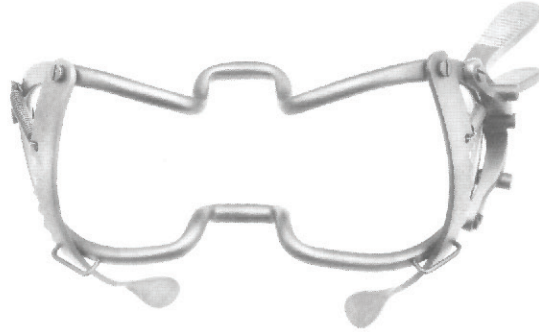

WHITEHEAD

- OI 23-6915-11 11 cm/4³/₄"
- OI 23-6915-13 13 cm/5¹/₈"
- OI 23-6915-15 15 cm/5⁷/₈"

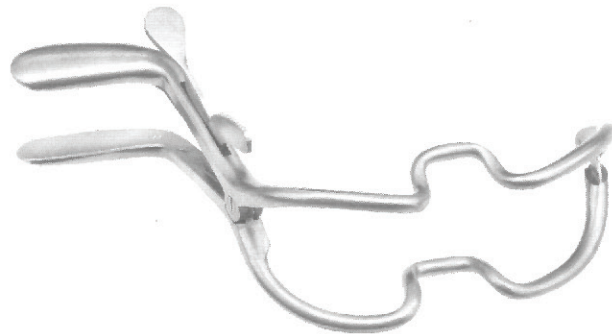

JENNINGS

- OI 23-6916-09 9 cm/3 1/2"
- OI 23-6916-11 11 cm/4³/₈"
- OI 23-6916-13 13 cm/5¹/₈"
- OI 23-6916-15 15 cm/5⁷/₈"

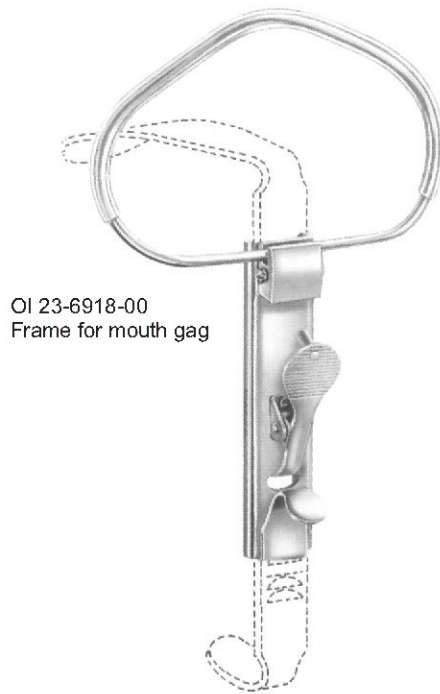

OI 23-6918-00
Frame for mouth gag

McLVOR
OI 23-6917-00
Complete with 3
tongue depressors

Tongue Depressors

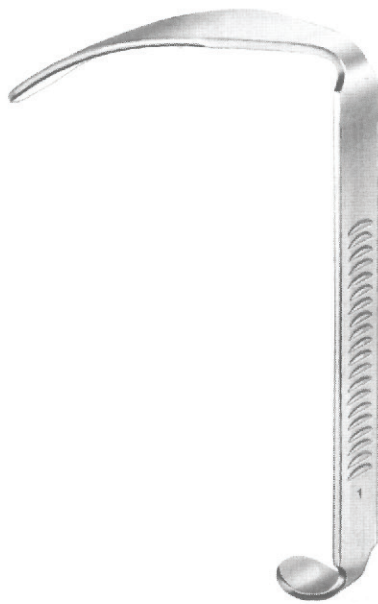

Fig. 1
OI 23-6919-01
100 x 25 mm



Fig. 2
OI 23-6920-02
85 x 25 mm

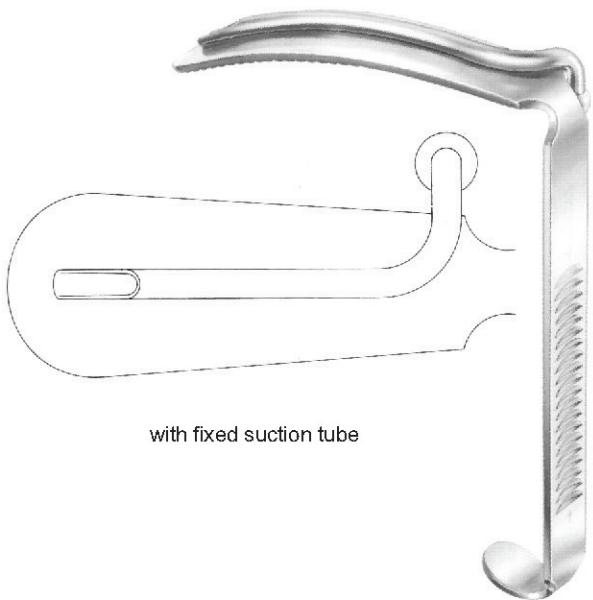

Fig. 3
OI 23-6921-03
75 x 25 mm

OI 23-6923-00
 Frame for mouth gag



DAVIS-BOYLE
 OI 23-6922-00
 Complete, consisting of frame
 and 5 tongue depressors no. 1 - 5



with fixed suction tube

Fig. 1
 OI 23-6924-01
 110 x 28 mm



Fig. 2
 OI 23-6925-02
 95 x 27 mm



Fig. 3
 OI 23-6926-03
 80 x 27 mm



Fig. 4
 OI 23-6927-04
 65 x 26 mm



Fig. 5
 OI 23-6928-05
 30 x 20 mm

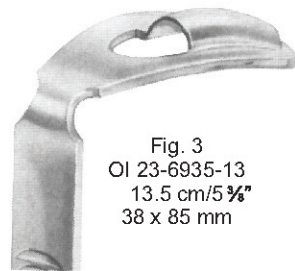
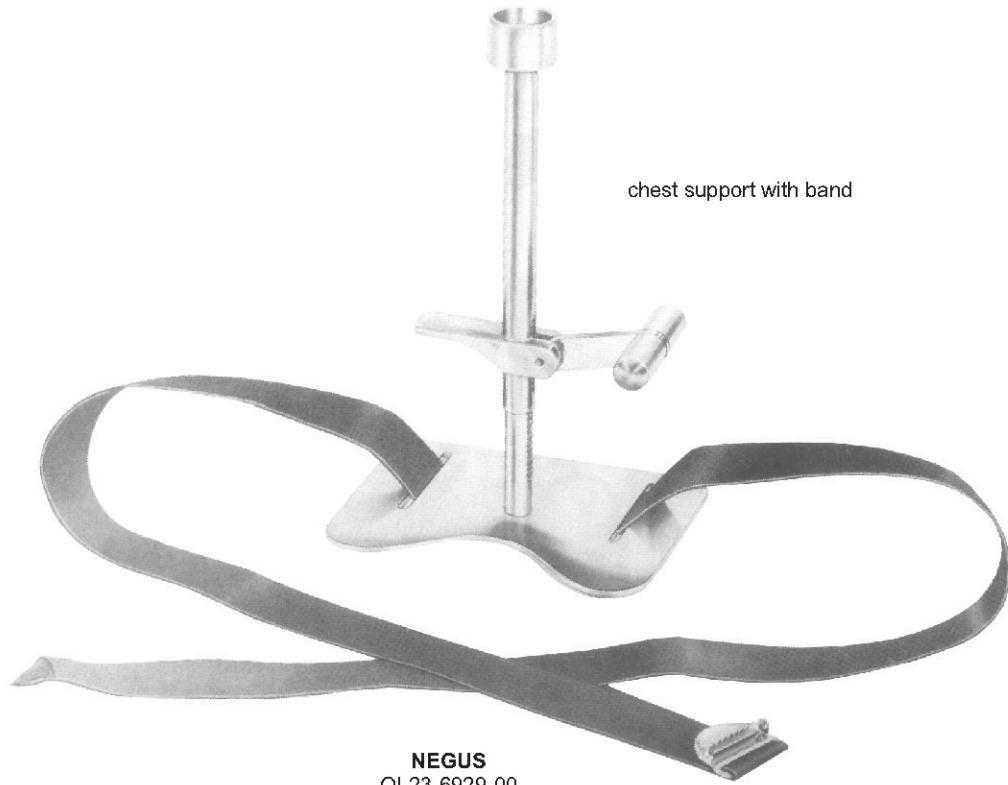

complete, consisting of frame and 3 tongue depressors
no. 1 to 3, 2 tooth plates and 1 palate plate

NEUKAM
 OI 23-6937-00
 frame for mouth gag only



NEUKAM
 OI 23-6936-00
 complete with frame and
 3 tongue depressors

Tongue Depressor
 fenestrated blade for suction

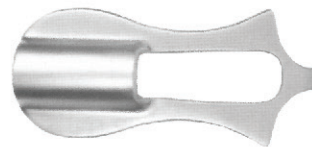
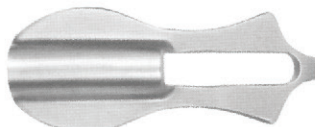
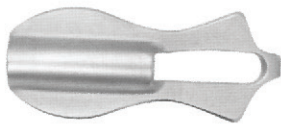

Fig. 1
 OI 23-6938-01

Fig. 2
 OI 23-6939-02

Fig. 3
 OI 23-6940-03



COLLIN
 OI 23-6941-16 16 cm/6 1/4"
 OI 23-6941-18 18 cm/7 1/8"

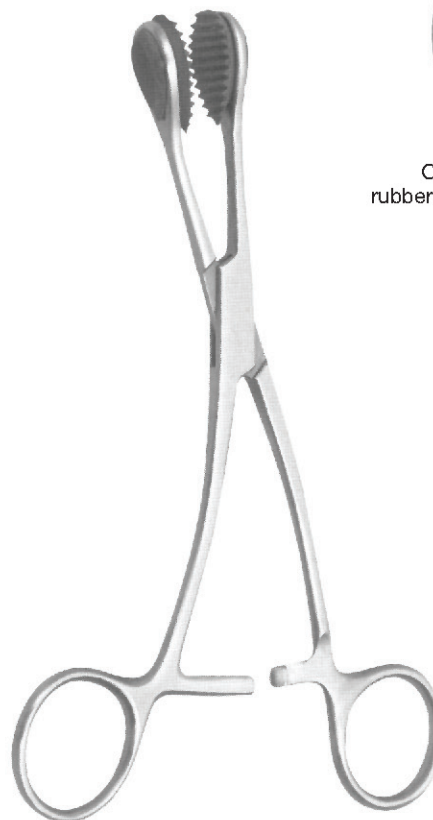

YOUNG
 OI 23-6942-16
 16 cm/6 1/4"



OI 23-6943-16
 rubber inserts, only (pair)



OI 23-6944-15
 15 cm/5 7/8"
 wood
 19 mm



OI 23-6945-15
 15 cm/5 7/8"
 plastic



BRUNINGS
 OI 23-6946-19
 19 cm/7 1/2"



16 mm

OI 23-6947-14
 14.5 cm/5 3/4"



19 mm

23 mm

OI 23-6948-14
 14 cm/5 1/2"



DOYEN

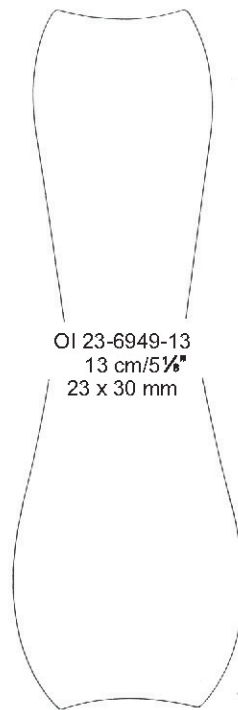

OI 23-6949-13
 13 cm/5 1/8"
 23 x 30 mm

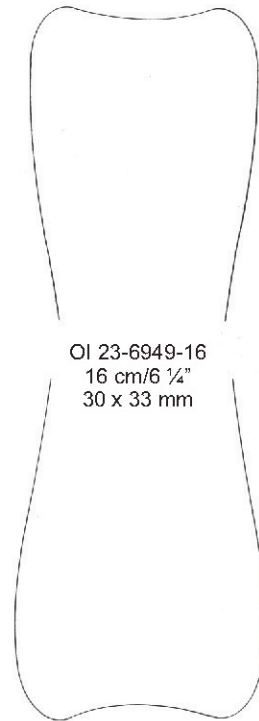

OI 23-6949-16
 16 cm/6 1/4"
 30 x 33 mm



TOBOLD
OI 23-6950-15
15 cm/5 1/8"

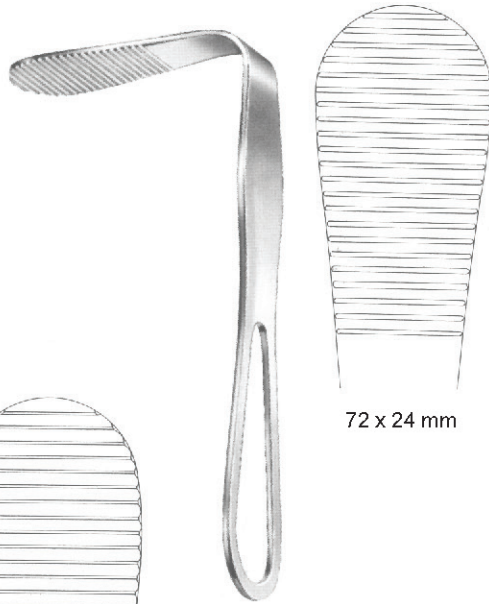

HARTMANN
OI 23-6951-15
15 cm/5 1/8"



TOBOLD
OI 23-6952-16
16 cm/6 1/4"

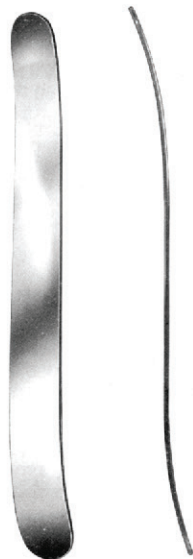

BUCHWALD
OI 23-6953-18
18 cm/7 1/8"



ANDREW
OI 23-6954-11
11 cm/4 3/8"

WIEDER

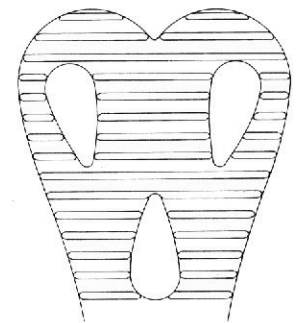

OI 23-6955-14
14 cm/5 1/2"
36 mm

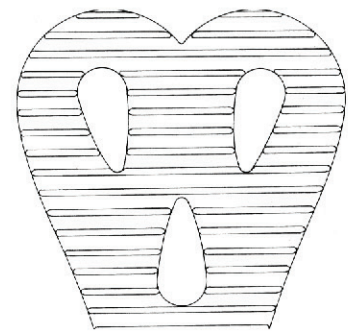

OI 23-6955-15
15 cm/5 3/8"
43 mm



MARTIN-SIMPLEX
 OI 23-6956-10
 10.5 cm/4 1/8"



OI 23-6957-14
 14 cm/5 1/2"
 Vestibulum
 retractor

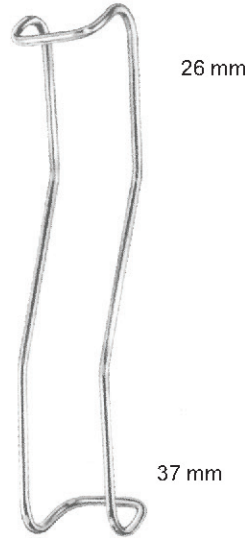

STERNBERG
 OI 23-6958-14
 14 cm/5 1/2"

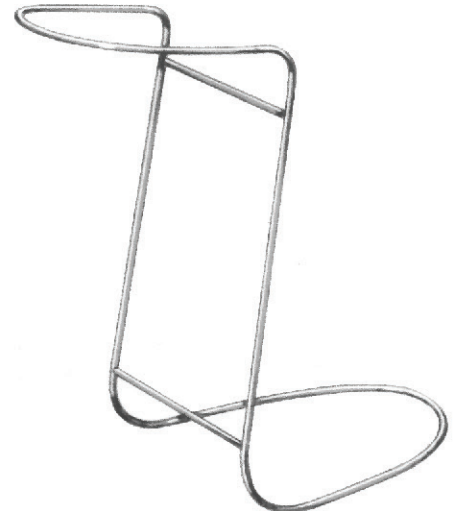

OBWEGESER
 OI 23-6959-12
 12 cm/4 3/4"



BISHOP
 OI 23-6960-13
 13.5 cm/5 3/8"



CAWOOD-MINNESOTA
 OI 23-6961-15
 15.5 cm/6 1/8"

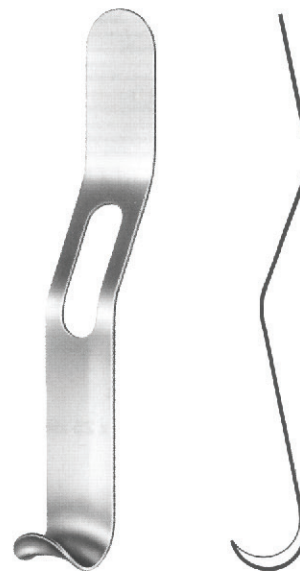

CAWOOD-MINNESOTA
 OI 23-6962-14
 14.5 cm/5 3/4"

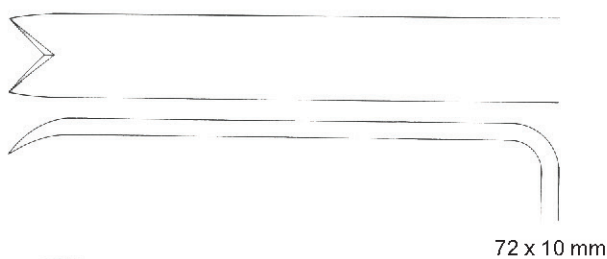

OBWEGESER
OI 23-6963-22
22 cm/8 3/4"



OBWEGESER
OI 23-6964-16
16.5 cm/6 1/2"



OI 23-6965-16
16 cm/6 1/4"
8 mm

OI 23-6966-16
16 cm/6 1/4"
10 mm

OBWEGESER

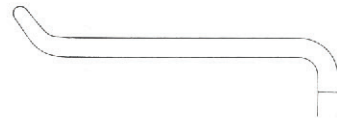

OI 23-6967-22
 22.5 cm/8 3/4"
 43 x 11 mm

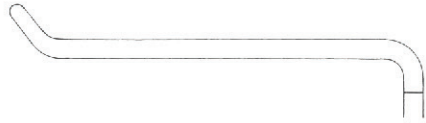

OI 23-6967-23
 23 cm/9"
 57 x 11 mm



OI 23-6968-23
 23 cm/9"
 80 x 16 mm

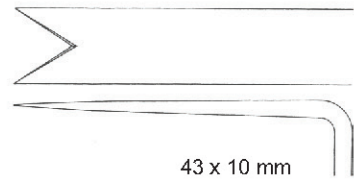

43 x 10 mm



OBWEGESER



OBWEGESER
 OI 23-6969-22
 22 cm/8 3/4"
 Nasal Spine Retractor



OBWEGESER
17.5 cm/6 7/8"



OI 23-6970-17



OI 23-6971-17



KRENKEL
24.5 cm/9 5/8"



OI 23-6972-24
Periosteal Elevator



OI 23-6973-24
Periosteal Elevator



OI 23-6974-24
Condylar repositioning
instrument
Fig. 11



OI 23-6975-24
Fig. 12





OBWEGESER
17.5 cm/6 7/8"



OI 23-6976-17
6 mm



OI 23-6977-17
7 mm



OI 23-6978-17
9 mm



OI 23-6979-17



OBWEGESER
20 cm/7 7/8"



OI 23-6980-20
5 mm



OI 23-6981-20
7 mm

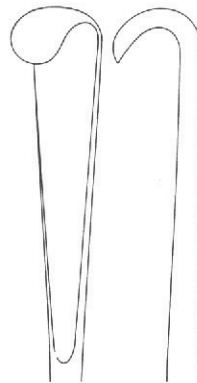

OI 23-6982-20
9 mm



OBWEGESER
 OI 23-6983-20
 20.5 cm/8 1/8"



OBWEGESER
 OI 23-6984-20
 20.5 cm/8 1/8"



OBWEGESER
 15 cm/5 7/8"



OI 23-6985-15
 2.5 mm



OI 23-6986-15
 4.0 mm

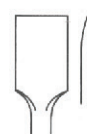

OI 23-6987-15
 6.5 mm

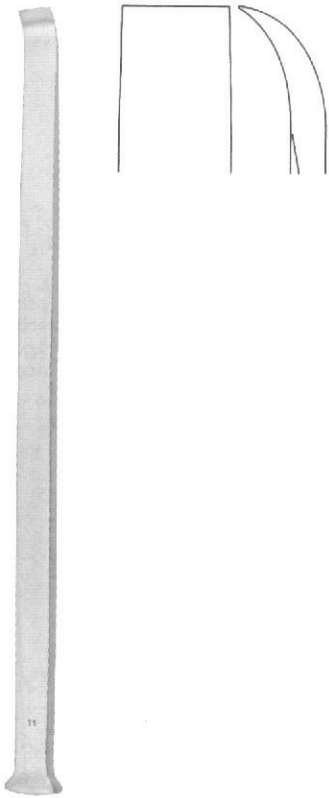

OBWEGESER
 OI 23-6988-23
 23.5 cm/9 1/4"



OI 23-6989-18



OI 23-6990-18

OBWEGESER
 18.5 cm/7 1/4"



OBWEGESER
 OI 23-6991-18
 18 cm/7 1/8"



OBWEGESER
 OI 23-6992-14
 14 cm/5 1/2"



OBWEGESER
 OI 23-6993-23
 23 cm/9"



Awl for lower jaw

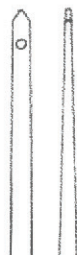

KELSEY-FRY
OI 23-6994-15
15 cm/5 7/8"



Awl for upper jaw



KELSEY-FRY
OI 23-6995-18
18 cm/7 1/8"

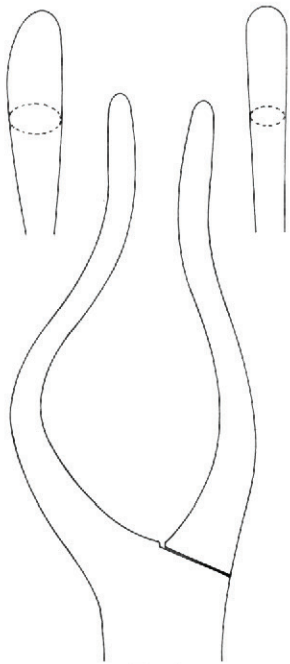

Fig. 1
 for babies

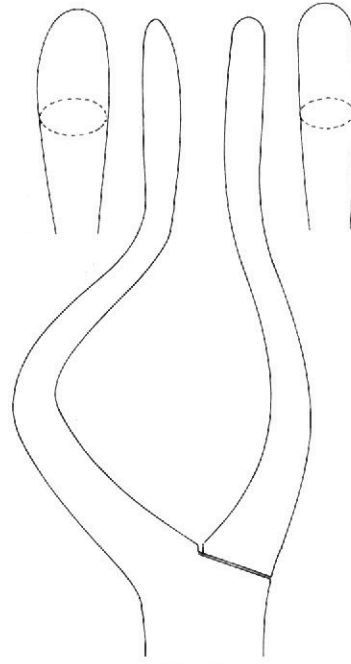

Fig. 2
 for children

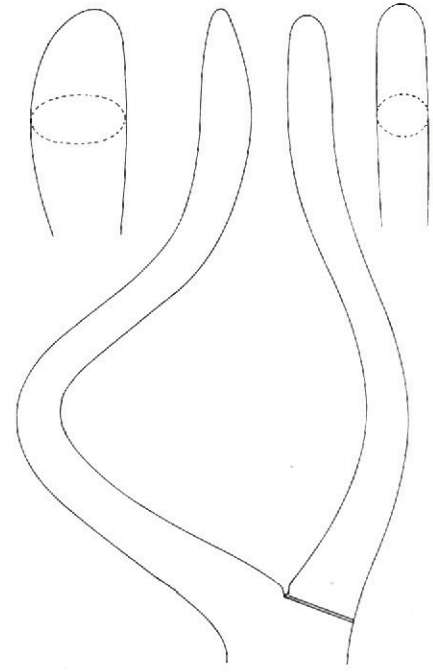

Fig. 3
 for adults



Left

ROWE

OI 23-6996-22 Fig. 1 22.5 cm
 OI 23-6996-23 Fig. 2 23.5 cm
 OI 23-6996-24 Fig. 3 24.0 cm



Right

ROWE

OI 23-6997-22 Fig. 1 22.5 cm
 OI 23-6997-23 Fig. 2 23.5 cm
 OI 23-6997-24 Fig. 3 24.0 cm